



mm PT9CN

Description

- Linear Position/Velocity to 550 inches (1400 cm)
- Aluminum or Stainless Steel Enclosure Options
- VLS Option To Prevent Free-Release Damage
- IP67 · NEMA 6 Protection



The PT9CN communicates linear position feedback via the CANbus SAE J1939 interface. The PT9CN has been designed for factory and harsh environment applications requiring full stroke ranges up to 550".

As a member of our innovative family of NEMA 4 rated cable-extension transducers, the PT9CN installs in minutes by simply mounting it's body to a fixed surface and attaching it's cable to the movable object. Perfect parallel alignment not required.

GENERAL

Full Stroke Range Options (on this datasheet)	0-75 to 0-550 inches
Electrical Signal Interface	CANbus SAE J1939
Protocol	Proprietary B
Accuracy	± 0.10% full stroke
Repeatability	± 0.02% full stroke
Resolution	± 0.003% full stroke
Measuring Cable Options	nylon-coated stainless steel or thermoplastic
Enclosure Material	powder-painted aluminum or stainless steel
Sensor	plastic-hybrid precision potentiometer
Potentiometer Cycle Life	≥ 250,000 cycles
Maximum Retraction Acceleration	see ordering information
Maximum Velocity	see ordering information
Weight, Aluminum (Stainless Steel) Enclosure	8 lbs. (16 lbs.), max.

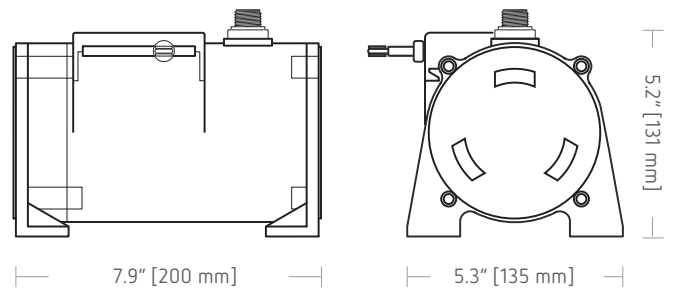

ELECTRICAL

Input Voltage	7 - 18 VDC
Input Current	60 mA max.
Address Setting/Node ID	0...63 set via DIP switches
Baud Rate	125K, 250K or 500K set via DIP switches
Update Rate	10 ms. (20 ms. available, contact factory)

ENVIRONMENTAL

Enclosure	NEMA 4/4X/6, IP 67
Operating Temperature	-40° to 200°F (-40° to 90°C)
Vibration	up to 10 g to 2000 Hz maximum

Output signal

data stream { 0000x0 FFFFx0 }



I/O Format and Settings

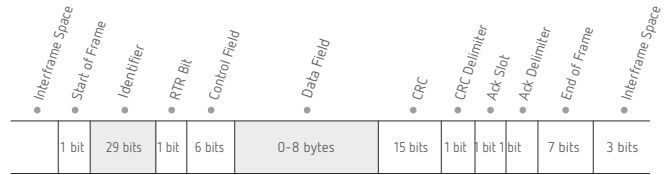

repetition = 8 msec.

Identifier

	Message Priority				Future Use		J1939 Reference Proprietary B								Data Field Type*						Not Used		Node ID**										
Example	1	0	0	0	0	0	1	1	1	1	1	1	1	1	1	1	0	1	0	1	0	0	1	1	0	0	1	1	1	1	1	1	1
Identifier Bit No.	28	27	26	25	24	23	22	21	20	19	18	17	16	15	14	13	12	11	10	9	8	7	6	5	4	3	2	1	0				
Hex Value	0				F				F				5				3				3		F										

*Sensor field data can be factory set to customer specific value. **Customer defined, set via Dips 1-6. Bit values shown for example only, see Address Setting below.

Data Field

B₀ = LSB current % of measurement range byte
B₁ = MSB current % of measurement range byte

B₂ = LSB current measurement count byte
B₃ = MSB current measurement count byte

B₄ = error flag
B₅ = error flag

B₆ = LSB velocity data byte
B₇ = MSB velocity data byte

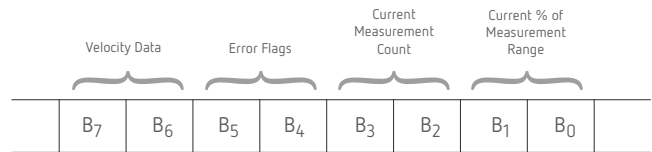

Current Measurement Count

The Current Measurement Count (CMC) is the output data that indicates the present position of the measuring cable. The CMC is a 16-bit value that occupies bytes B₂ and B₃ of the data field. B₂ is the LSB (least significant byte) and B₃ is the MSB (most significant byte).

The CMC starts at 0x0000 with the measuring cable fully retracted and continues upward to the end of the stroke range stopping at 0xFFFF. This holds true for all ranges.

Converting CMC to Linear Measurement

To convert the current measurement count to inches or millimeters, simply divide the count by 65,535 (total counts over the range) and then multiply that value by the full stroke range:

$$\left(\frac{\text{current measurement count}}{65,535} \right) \times \text{full stroke range}$$

Sample Conversion:

If the full stroke range is 30 inches and the current position is 0x0FF2 (4082 Decimal) then,

$$\left(\frac{4082}{65,535} \right) \times 30.00 \text{ inches} = 1.87 \text{ inches}$$

If the full stroke range is 625 mm and the current position is 0x0FF2 (4082 Decimal) then,

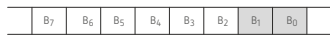
$$\left(\frac{4082}{65,535} \right) \times 625 \text{ mm} = 39 \text{ mm}$$

Current % of Measurement Range

The Current % of Measurement Range is a 2-byte value that expresses the current linear position as a percentage of the entire full stroke range. Resolution is .1 % of the full stroke measurement range.

This value starts at 0x0000 at the beginning of the stroke and ends at 0x03E8.

Example:

Hex	Decimal	Percent
0000	0000	0.0%
0001	0001	0.1%
0002	0002	0.2%
...
03E8	1000	100.0%



Error Flags

0x55 (yellow LED on controller board) indicates that the sensor has begun to travel beyond the calibrated range of the internal position potentiometer.

0xAa (red LED on controller board) indicates that the sensor has moved well beyond the calibrated range of the internal position potentiometer.

If either error flag occurs within the full stroke range of the sensor, the unit should be returned to the factory for repair and recalibration.

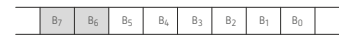

Velocity

Data in bytes B₇ - B₆ is the change in the CMC (current measurement count) over a 100 msec time period. This data can then be used to calculate velocity in a post processing operation.

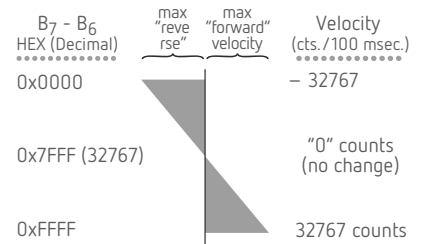

Velocity Calculation

$$\left(\frac{\text{count change} - 32767}{.1 \text{ sec. time period}} \right) \times \left(\frac{\text{full stroke range}}{65,535} \right)$$

Sample Calculations

Cable Extension (positive direction):

B₇-B₆ = 0x80C6 (32966 Dec), full stroke = 200 in.

$$\left(\frac{32966 - 32767}{32767.1} \right) \times \left(\frac{200 \text{ in.}}{65,535} \right) = 6.07 \text{ in. / sec.}$$

Cable Retraction (negative direction):

B₇-B₆ = 0x7F1A (32538 Dec), full stroke = 200 in.

$$\left(\frac{32538 - 32767}{32767.1} \right) \times \left(\frac{200 \text{ in.}}{65,535} \right) = -6.99 \text{ in. / sec.}$$

Setting the Address (Node ID) and Baud Rate

Address Setting (Node ID)

The Address Setting (Node ID) is set via 6 switches located on the 8-pole DIP switch found on the DeviceNET controller board located inside the transducer.

The DIP switch settings are binary starting with switch number 1 (= 2⁰) and ending with switch number 6 (= 2⁵).

DIP-1 (2 ⁰)	DIP-2 (2 ¹)	DIP-3 (2 ²)	DIP-4 (2 ³)	DIP-5 (2 ⁴)	DIP-6 (2 ⁵)	address (decimal)
0	0	0	0	0	0	0
1	0	0	0	0	0	1
0	1	0	0	0	0	2
...
1	1	1	1	1	1	63

Baud Rate

The transmission baud rate may be either factory preset at the time of order or set manually at the time of installation.

The baud rate can be set using switches 7 & 8 on the 8-pole DIP switch found on the DeviceNET controller board located inside the transducer.

DIP-7	DIP-8	baud rate
0	0	125k
1	0	250k
0	1	500k
1	1	125k



CANBus Controller Board

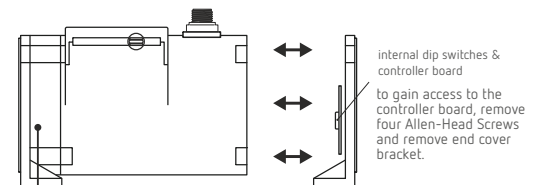
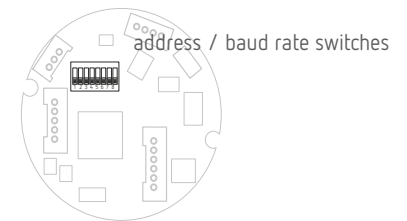

Caution! Do Not Remove Spring-Side End Cover removing spring-side end cover could cause spring to become unseated and permanently damaged.

Fig. 1 – Outline Drawing (18 oz. cable tension only)

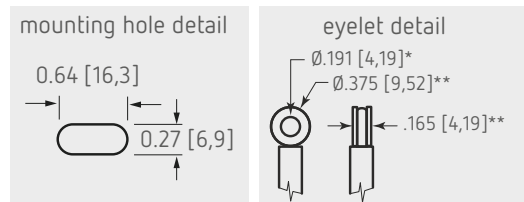
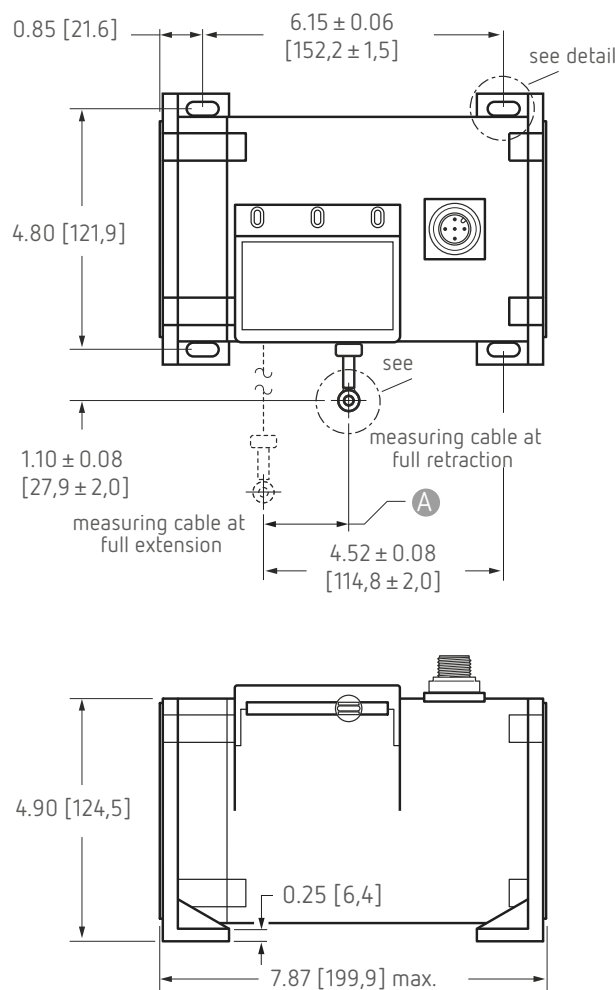

A DIMENSION (INCHES)

RANGE	MEASURING CABLE			
	Ø.031 in.	Ø.034 in.	Ø.047 in.	Ø.062 in.
75	n/a	0.22	0.29	0.37
100	n/a	0.29	0.39	0.49
150	n/a	0.44	0.59	0.73
200	n/a	0.58	0.79	0.98
250	n/a	0.73	0.98	1.22
300	n/a	0.88	1.18	1.47
350	n/a	1.02	1.38	1.71
400	n/a	1.17	1.57	1.96
450	n/a	1.31	1.77	n/a
500	n/a	1.46	1.97	n/a
550	1.61	1.61	n/a	n/a

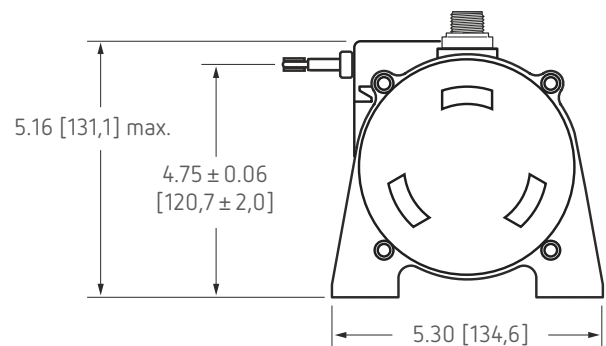

DIMENSIONS ARE IN INCHES [MM]
tolerances are 0.03 IN. [0.5 MM] unless otherwise noted.

* tolerance = +.005 - .001 [+ .13 - .03]
** tolerance = +.005 - .005 [+ .13 - .13]

Ordering Information

Model Number

PT9CN - _____
order code: **R** **A** **B** **C** **D** **E** **F** **G** **H**

Sample Model Number:

PT9CN - 200 - AL - N34 - 26 - FR - J - 500 - 32 - SC5

- R** range: 200 inches
- A** enclosure: aluminum
- B** measuring cable: .034 nylon-coated stainless
- C** measuring cable tension: 18 oz.
- D** cable exit: front (horizontal)
- E** interface: CANbus SAE J1939
- F** baud rate: 500 k bits/sec.
- G** node ID: 32 decimal
- H** electrical connection: 5-meter cordset with straight plug

Full Stroke Range:

R order code:	75	100	150	200	250	300	350	400	450*	500*	550*
full stroke range, min:	75 in.	100 in.	150 in.	200 in.	250 in.	300 in.	350 in.	400 in.	450 in.	500 in.	550 in.

* - 36 oz. cable tension strongly recommended

Enclosure Material:

A order code:	AL	SS
	powder-painted aluminum	303 stainless

Measuring Cable:

B order code:	N34	S47	S31	V62
cable construction:	Ø.034-inch nylon-coated stainless steel rope	Ø.047-inch bare stainless steel rope	Ø.031-inch bare stainless steel rope	Ø.058-inch PVC jacketed vectra fiber rope
available ranges:	all ranges	all ranges up to 500 inches	550 inch range only	all ranges up to 400 inches
general	indoor	outdoor, debris, high temperature	outdoor, debris, high temperature	high voltage or magnetic field

Measuring Cable Tension:

C order code:	26	52		
tension (30%):	18 oz.	36 oz.		
enclosure material:	aluminum	stainless steel	aluminum	stainless steel
max. acceleration:	1 g	.33 g	5 g	2 g
max. velocity:	60 inches/sec	20 inches/sec	200 inches/sec	80 inches/sec

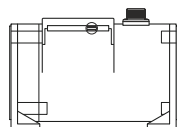

standard housing
see fig 1.

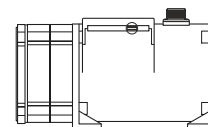

dual-spring
housing

Cable Exit:

D order code:	FR	UP	BK	DN
	front	top	back	down

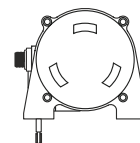
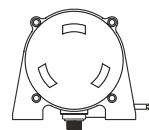
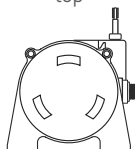
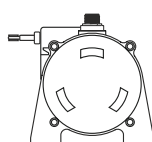

Baud Rate:

F Ordercode:	125	250	500
	125 kbaud	250 kbaud	500 kbaud

Ordering Information (cont.):

Node ID:

G	order code:	0	1	2	3	...	61	62	63
select address (0 - 63 Decimal)									

Electrical Connection:

H	order code:	blank	MC5	SC5	NC5																		
		5-pin micro-connector (no mating plug)	5-pin micro-connector w/ mating	5-pin micro-connector and 5 meter length cordset w/straight mating plug	5-pin micro-connector and 5 meter length cordset w/90° mating plug																		
		<p>connector (contact view)</p>																					
			<p>mating plug (contact view)</p>	<table border="1"> <thead> <tr> <th>pin</th> <th>signal</th> <th>wire color</th> </tr> </thead> <tbody> <tr> <td>1</td> <td>signal drain</td> <td>brown</td> </tr> <tr> <td>2</td> <td>V+ white</td> <td></td> </tr> <tr> <td>3</td> <td>V- blue</td> <td></td> </tr> <tr> <td>4</td> <td>Can-H black</td> <td></td> </tr> <tr> <td>5</td> <td>Can-L</td> <td>grey</td> </tr> </tbody> </table>	pin	signal	wire color	1	signal drain	brown	2	V+ white		3	V- blue		4	Can-H black		5	Can-L	grey	
pin	signal	wire color																					
1	signal drain	brown																					
2	V+ white																						
3	V- blue																						
4	Can-H black																						
5	Can-L	grey																					

VLS Option - Free Release Protection

The patented Velocity Limiting System (VLS) is an option for PT9000 Series cable extension transducers that limits cable retraction to a safe 40 to 55 inches per second for the single spring option and 40 to 80 inches per second for the higher tension dual spring option.

The VLS option prevents the measuring cable from ever reaching a damaging velocity during an accidental free release. This option is ideal for mobile applications that require frequent cable disconnection and reconnection. It prevents expensive unscheduled downtime due to accidental cable mishandling or attachment failure.

How To Configure Model Number for VLS Option:

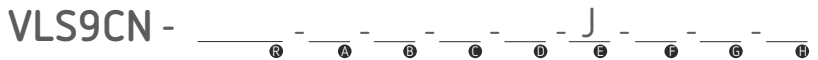

creating VLS model number

- | | |
|--------------------------------------|---------------------------------|
| 1. select PT9CN model | PT9CN-200-N34-26... |
| 2. remove "PT" from the model number | PT 9CN-200-N34-26... |
| 3. add "VLS" | VLS + CN-200-N34-26... |
| | VLS9CN-200-N34-26... |

■ Fig. 2 – Outline Drawing (36 oz. cable tension only)

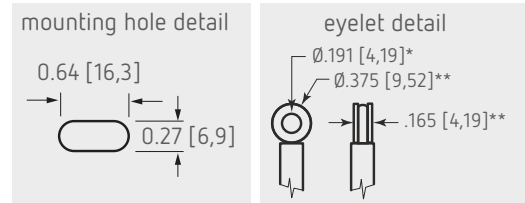
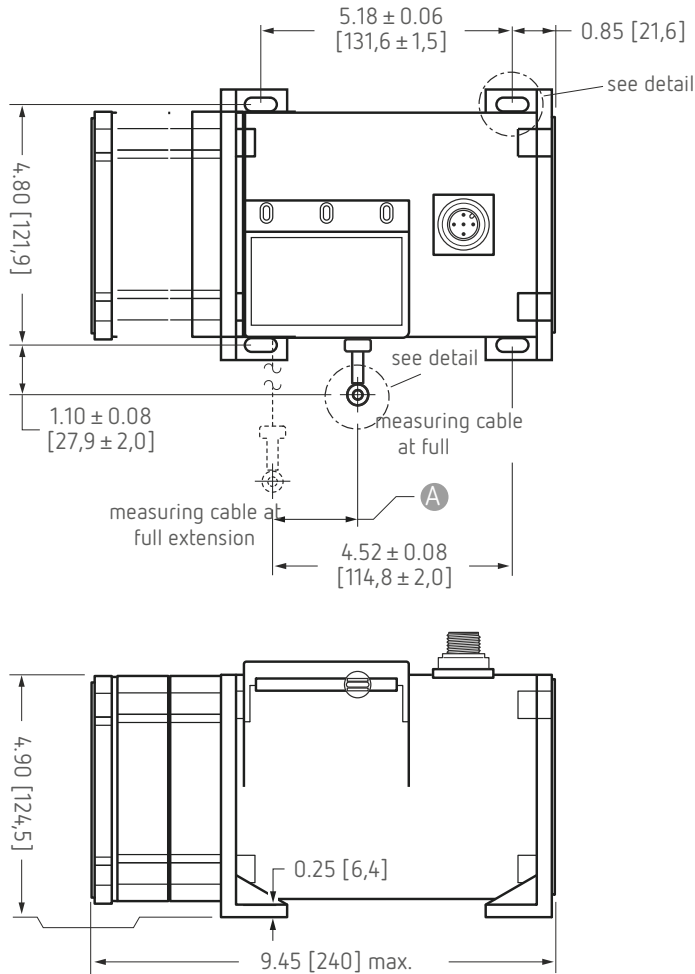

Ⓐ DIMENSION (INCHES)

RANGE	MEASURING CABLE			
	Ø.031 in.	Ø.034 in.	Ø.047 in.	Ø.062 in.
75	n/a	0.22	0.29	0.37
100	n/a	0.29	0.39	0.49
150	n/a	0.44	0.59	0.73
200	n/a	0.58	0.79	0.98
250	n/a	0.73	0.98	1.22
300	n/a	0.88	1.18	1.47
350	n/a	1.02	1.38	1.71
400	n/a	1.17	1.57	1.96
450	n/a	1.31	1.77	n/a
500	n/a	1.46	1.97	n/a
550	1.61	1.61	n/a	n/a

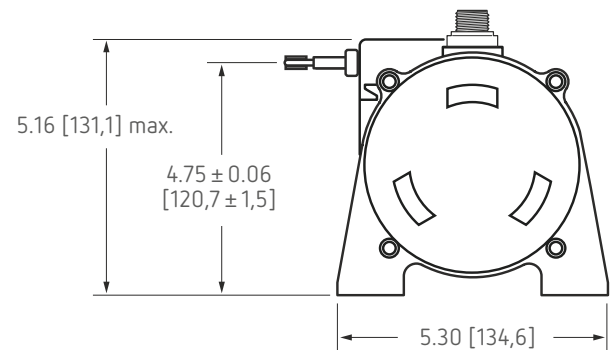

DIMENSIONS ARE IN INCHES [MM]
 tolerances are 0.03 IN. [0.5 MM] unless otherwise noted.

* tolerance = +.005 -.001 [+13 -.03]
 ** tolerance = +.005 -.005 [+13 -.13]

The information provided herein is to the best of our knowledge true and accurate, it is provided for guidance only. All specifications are subject to change without prior notification.

Althen – Your expert partner in Sensors & Controls | althensensors.com

Althen stands for pioneering measurement and custom sensor solutions. In addition we offer services such as calibration, design & engineering, training and renting of measurement equipment.

Germany/Austria/Switzerland
info@althen.de

Benelux
sales@althen.nl

France
info@althensensors.fr

Sweden
info@althensensors.se

USA/Canada
info@althensensors.com

Other countries
info@althensensors.com