



mm PT5DN

Description

- Absolute Linear Position to 250 inches (6350 mm)
- Hard Anodized Aluminum Enclosure
- High Cycle Applications
- IP67 • NEMA 6 Protection



The PT5DN, using a high cycle plastic-hybrid potentiometer, communicates via DeviceNET protocol with programmable controllers in factories and harsh environments requiring linear position measurements in ranges up to 250". As a member of our innovative family of NEMA 4 rated cable-extension transducers, the PT5DN installs in minutes by simply mounting it's body to a fixed surface and attaching it's cable to the movable object. Perfect parallel alignment not required.

GENERAL

Full Stroke Ranges	0-10 to 0-250 inches
Electrical Interface	CANbus ISO 11898
Protocol	DeviceNET version 2.0
Accuracy	± 0.25% to ± 0.10% full stroke
Repeatability	± 0.02% full stroke
Resolution	± 0.003% full stroke
Measuring Cable	stainless steel or thermoplastic
Enclosure Material	hardanodized aluminum
Sensor	plastic-hybrid precision potentiometer
Potentiometer Cycle Life	see ordering information
Maximum Retraction Acceleration	see ordering information
Weight	5 lbs. max.

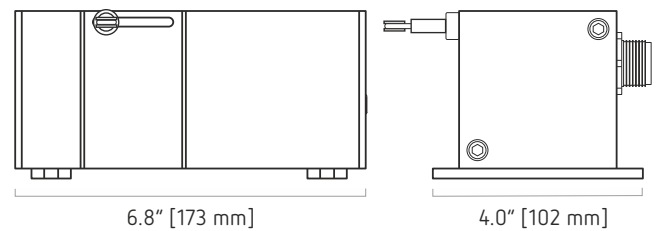

Output signal

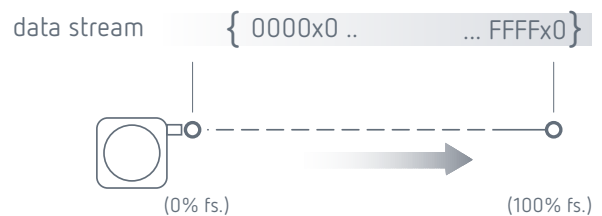

ELECTRICAL

Input Voltage	bus powered
Input Current	40 mA
Address Setting/Node ID	0...63 set via DIP switches – default setting: 63
Baud Rate	125K, 250K or 500K set via DIP switches
EDS File	available @ http://www.celesco.com/download

ENVIRONMENTAL

Environmental Suitability	NEMA 4/6, IP 67
Operating Temperature	-40° to 185°F (-40° to 85°C)
Vibration	up to 10 g to 2000 Hz maximum

I/O Format

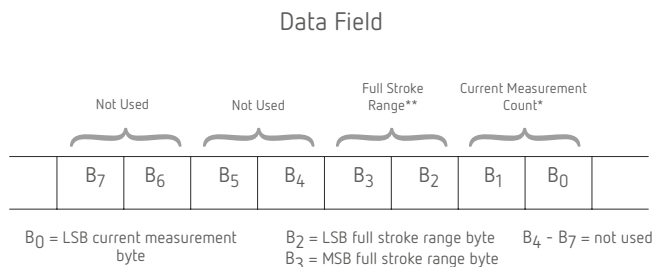
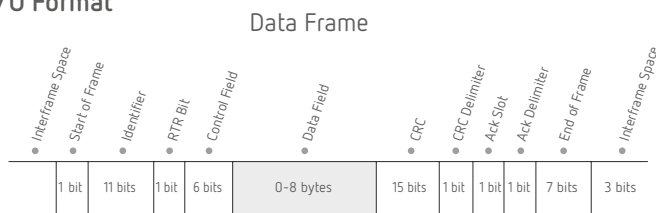

***Current Measurement Count**

The Current Measurement Count (CMC) is the output data that indicates the present position of the measuring cable.

The CMC is a 16-bit value that occupies the first two bytes (B₀ and B₁) of the data field. B₀ is the LSB (least significant byte) and B₁ is the MSB (most significant byte).

The CMC starts at 0000H with the measuring cable fully retracted and continues upward to the end of the stroke range stopping at FFFFH. This holds true for all ranges.

****Full Stroke Range**

The Full Stroke Range (FSR) is a 16-bit value in the data field that expresses the full range of the sensor in inches. This value can be used to convert the actual count to units of measurement should the application require it.

The full stroke measurement range occupies the second two bytes (B₂ and B₃) of the data field.

B₂ is the LSB (least significant byte) and B₃ is the MSB (most significant byte).

This value is expressed in inches.

Example:

Hex Value	Decimal Equivalent	Full Stroke Range
001E	30	30 inches

Converting CMC to Inches

If required, the CMC can easily be converted to a linear measurement expressed in inches instead of just counts.

This is accomplished by first dividing the CMC by 65,535 (total counts over the range) and then multiplying that value by the FSR:

$$\left(\frac{\text{CMC}}{65,535} \right) \times \text{FSR}$$

Example:

If the full stroke range is 30 inches and the current position is 0FF2 Hex (4082 Decimal) then,

$$\left(\frac{4082}{65,535} \right) \times 30.00 \text{ inches} = 1.87 \text{ inches}$$

Address Setting (Node ID), Baud Rate and Bus Termination Settings

Address Setting (Node ID)

The Address Setting (Node ID) is set via 6 switches located on the 8-pole DIP switch found on the DeviceNET controller board located inside the transducer.

The DIP switch settings are binary starting with switch number 1 (= 2⁰) and ending with switch number 6 (= 2⁵).

DIP-1 (2 ⁰)	DIP-2 (2 ¹)	DIP-3 (2 ²)	DIP-4 (2 ³)	DIP-5 (2 ⁴)	DIP-6 (2 ⁵)	address (decimal)
0	0	0	0	0	0	0
1	0	0	0	0	0	1
0	1	0	0	0	0	2
...
1	1	1	1	1	1	63



Baud Rate

The transmission baud rate may be either factory preset at the time of order or set manually at the time of installation.

The baud rate can be set using switches 7 & 8 on the 8-pole DIP switch found on the DeviceNET controller board located inside the transducer.

DIP-7	DIP-8	baud rate
0	0	125k
1	0	250k
0	1	500k
1	1	125k



Bus Termination

The setting of the internal bus termination resistor may be specified upon order or manually changed by the end user at the time of installation.

The bus termination resistor is activated setting switches 1 & 2 on the 2-pole DIP switch (located on the internal DeviceNET controller board) to the "ON" position.

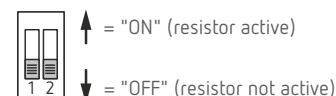

DeviceNET Controller Board and DIP Switch Location

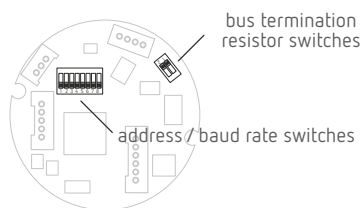

Caution! Do Not Remove Spring-Side End Cover removing spring-side end cover could cause spring to become unseated and permanently damaged.

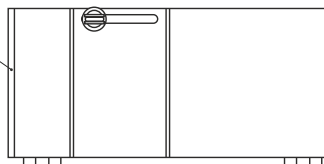

internal dip switches & controller board
to gain access to the controller board, remove four Allen-Head Screws and remove end cover bracket.

Outline drawing

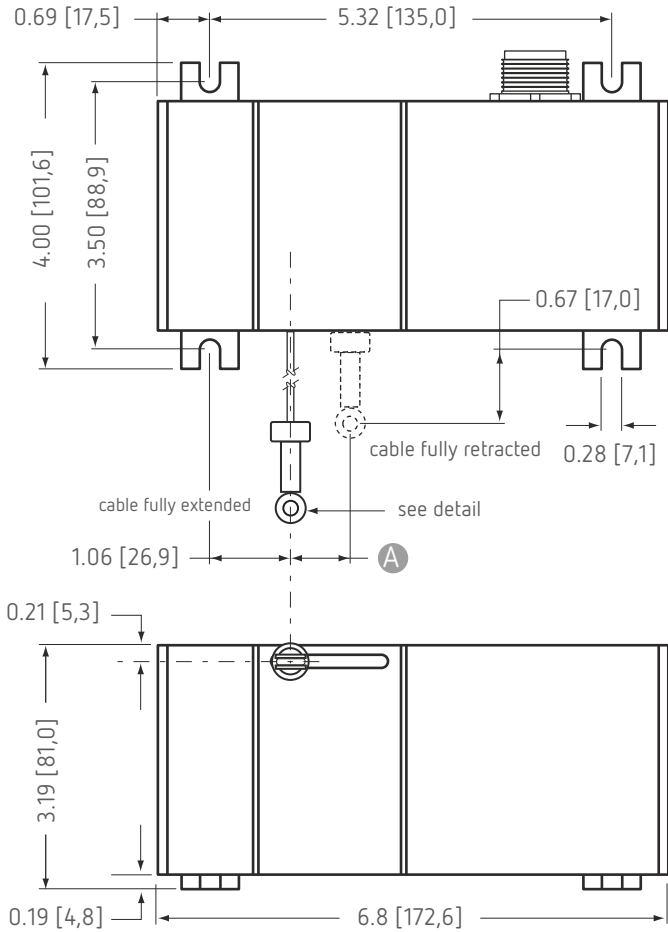

eyelet detail

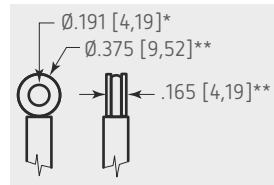

A DIMENSION (inches[mm])

RANGE	N34 measuring cable	S47 & V62 measuring cable
10	0.05 [1,2]	0.08 [2,0]
15	0.07 [1,8]	0.12 [3,0]
20	0.09 [2,4]	0.16 [3,9]
30	0.14 [3,5]	0.23 [5,9]
40	0.19 [4,7]	0.31 [7,9]
50	0.23 [5,9]	0.39 [9,9]
60	0.28 [7,0]	0.47 [11,8]
80	0.37 [9,4]	0.62 [15,8]
100	0.46 [11,7]	0.78 [19,7]
125	0.58 [14,7]	0.97 [24,7]
150	0.69 [17,6]	1.16 [29,6]
200	0.92 [23,5]	n/a
250	1.16 [29,3]	n/a

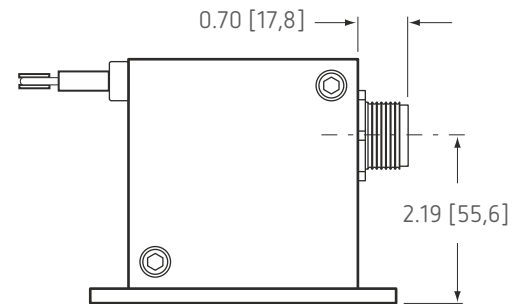

DIMENSIONS ARE IN INCHES [MM]
tolerances are 0.03 IN. [0.5 MM] unless otherwise noted.

* tolerance = +.005 - .001 [+ .13 - .03]
** tolerance = +.005 - .005 [+ .13 - .13]

Ordering Information:

Model Number:

PT5DN - - - - - -
order code: **R** **A** **B** **C** **D** **E**

Sample Model Number:

PT5DN - 50 - S47 - FR - 500 - TR - SC5

- R** range: 50 inches measuring
- A** cable: .047 stainless steel
- B** measuring cable exit: front
- C** baud rate: 500 k bits/sec.
- D** terminating resistor: yes
- E** electrical connection: 5-meter cordset with straight plug

Full Stroke Range:

R order code:	10	15	20	25	30	40	50	60	80	100	125	150	200	250
full stroke range, min:	10 in.	15 in.	20 in.	25 in.	30 in.	40 in.	50 in.	60 in.	80 in.	100 in.	125 in.	150 in.	200 in.	250 in.
accuracy (± % of f.s.):	.75%	.6%	.5%	.5%	.5%	.3%	.3%	.25%	.25%	.25%	.25%	.18%	.18%	.18%
repeatability (± % of f.s.):	.1%	.1%	.05%	.05%	.05%	.05%	.05%	.02%	.02%	.02%	.02%	.02%	.02%	.02%
potentiometer cycle life:	2,500,000 cycles							500,000 cycles			250,000 cycles			
cable tension (20%):	41 ounces												21 ounces	
max. cable velocity/acceleration:	300 in./sec • 5 g												120 in./sec • 2 g	

12.2015 | version 20140328 - Rev 3.0

■ Ordering Information (cont.)

Measuring Cable:

A order code:	N34	S47	V62
	.034 nylon-coated stainless steel	.047 stainless steel	.062 thermoplastic
	available in all ranges	all ranges up to 150 inches	all ranges up to 150 inches

Cable Exit:

B order code:	UP	DN	FR	BK
	up	down	front	back
	inches [mm]			

Baud Rate:

C Order code:	125	250	500
	125 kbaud	250 kbaud	500 kbaud

Terminating Resistor:

D order code:	TR	NR
	terminating resistor	no terminating resistor

Electrical Connection:

E order code:	blank	MC5	SC5	NC5																		
	5-pin micro-connector (no mating plug)	5-pin micro-connector w/ mating	5-pin micro-connector and 5 meter length cordset w/straight mating plug	5-pin micro-connector and 5 meter length cordset w/90° mating plug																		
	connector (contact view)																					
			<table border="1"> <thead> <tr> <th>pin</th> <th>signal</th> <th>wire color</th> </tr> </thead> <tbody> <tr> <td>1</td> <td>Drain</td> <td>brown</td> </tr> <tr> <td>2</td> <td>V+</td> <td>white</td> </tr> <tr> <td>3</td> <td>V-</td> <td>blue</td> </tr> <tr> <td>4</td> <td>Can-H</td> <td>black</td> </tr> <tr> <td>5</td> <td>Can-L</td> <td>grey</td> </tr> </tbody> </table>	pin	signal	wire color	1	Drain	brown	2	V+	white	3	V-	blue	4	Can-H	black	5	Can-L	grey	
pin	signal	wire color																				
1	Drain	brown																				
2	V+	white																				
3	V-	blue																				
4	Can-H	black																				
5	Can-L	grey																				

The information provided herein is to the best of our knowledge true and accurate, it is provided for guidance only. All specifications are subject to change without prior notification.

Althen – Your expert partner in Sensors & Controls | althensensors.com

Althen stands for pioneering measurement and custom sensor solutions. In addition we offer services such as calibration, design & engineering, training and renting of measurement equipment.

Germany/Austria/Switzerland
info@althen.de

Benelux
sales@althen.nl

France
info@althensensors.fr

Sweden
info@althensensors.se

USA/Canada
info@althensensors.com

Other countries
info@althensensors.com