



**A** FDRF096 Series

---



# LEAF SPRING HOLE INNER DIAMETER MEASUREMENT MACHINE

## FDRF096-30/75-120 Model USER MANUAL

## Contents

1. Safety precautions.....	3
2. CE compliance.....	3
3. Laser safety	
4. General information.....	3
5. Basic technical data	
6. Example of item designation when ordering	
7. Structure and operating principle.....	5
8. Connection.....	6
9. Network setting	
10. Intended use.....	6
10.1. Preparation for use	
10.2. How to install a leaf spring.....	6
11. Service program.....	7
11.1. System requirements	
11.2. Running the program.....	7
11.3. Authorization.....	7
11.4. Main window.....	8
11.5. Settings.....	9
11.5.1. "Settings" window.....	9
11.5.1.1. "SCAN" tab.....	9
11.5.1.2. "HARDWARE" tab.....	10
11.5.1.3. "REPORT" tab.....	11
11.5.1.4. "ABOUT" tab.....	12
11.5.2. "User Management" window.....	12
11.5.2.1. "My Account" tab.....	12
11.5.2.2. "Account Management" tab.....	13
11.5.3. "Connection" window.....	14
11.6. Calibration.....	14
11.7. Measurement.....	16
11.7.1. Scan session.....	16
11.7.2. Scanning .....	16
11.7.2.1. Creating the scan program and starting the scanning process.....	16
11.7.2.2. Ignore area.....	17
11.7.2.3. 3D view .....	18
11.7.2.4. Profile view.....	19
11.7.2.5. Zoom .....	20
11.7.3. Browsing the results	
11.7.4. History .....	20
11.7.5. Scan report.....	20
11.7.6. Export / Import data.....	20
11.8. Hot keys.....	21
12. Technical support.....	21
13. Warranty policy	
14. List of changes.....	21

## 1. Safety precautions

- Use supply voltage and interfaces indicated in the machine specifications.
- In connection/disconnection of cables, the system power must be switched off.
- Do not use the system in locations close to powerful light sources.

## 2. CE compliance

The machine has been developed for use in industry and meets the requirements of the following Directives:

- EU directive 2014/30/EU. Electromagnetic compatibility (EMC).
- EU directive 2011/65/EU, “RoHS” category 9.

## 3. Laser safety

The machine makes use of a c.w. 660 nm wavelength semiconductor laser. Maximum output power is 1 mW. The system belongs to the 2 laser safety class according to IEC/EN 60825-1:2014. The following warning label is placed on the housing:

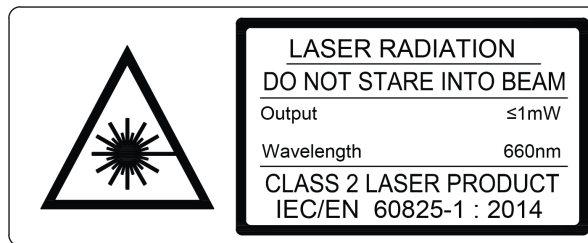

The following safety measures should be taken while operating the machine:

- Do not target laser beam to humans.
- Do not disassemble the laser sensor.
- Avoid staring into the laser beam.

## 4. General information

The machine is intended for non-contact scanning and inner diameter measurement of leaf springs holes.

## 5. Basic technical data

Parameter		Value
Measured ID range, mm		30...75
ID measurement accuracy, mm		±0.04
Angle scan resolution, points for turnover		3200
Hole depth measurement range, mm		120
Linear translation accuracy, mm		±0.05
Linear translation resolution, mm		programmable, from 0.02
Laser sensor linearity, µm		±20
Laser sensor resolution, µm		5
Laser sensor sample frequency, kHz		10
Light source		red semiconductor laser, 660 nm wavelength
Laser sensor output power, mW		1
Laser safety class		2 (IEC60825-1)
Interface		Ethernet
Power supply, V		220
Measurement speed, parts/s		programmable, depending on depth
Environmental resistance	Vibration	20 g / 10...1000 Hz, 6 hours for each of XYZ axes
	Shock	30 g / 6 ms
	Permissible ambient light, lx	30000
	Relative humidity, %	5-95 (no condensation)
	Operating ambient temperature, °C	0...+45
	Storage temperature, °C	-20...+70
Housing material		aluminum
Weight (without cables), gram		13000

**Note:** Machine parameters can be changed for a specific task.

## 6. Example of item designation when ordering

FDRF096-Dmin/Dmax-L

Symbol	Description
Dmin/Dmax	ID measurement range, mm.
L	Hole depth, mm.

## 7. Structure and operating principle

Operation of the machine is based on the scanning of the item inner hole surface by rotating point triangulation laser sensor.

The machine contains a base on which installed a table with the V-block and fixing screw (for placing the measured spring), linear translation mechanism, controller. The linear translation mechanism carries the rotation module on which the laser sensor installed. On the back side of the machine there are two connectors for power and interface.

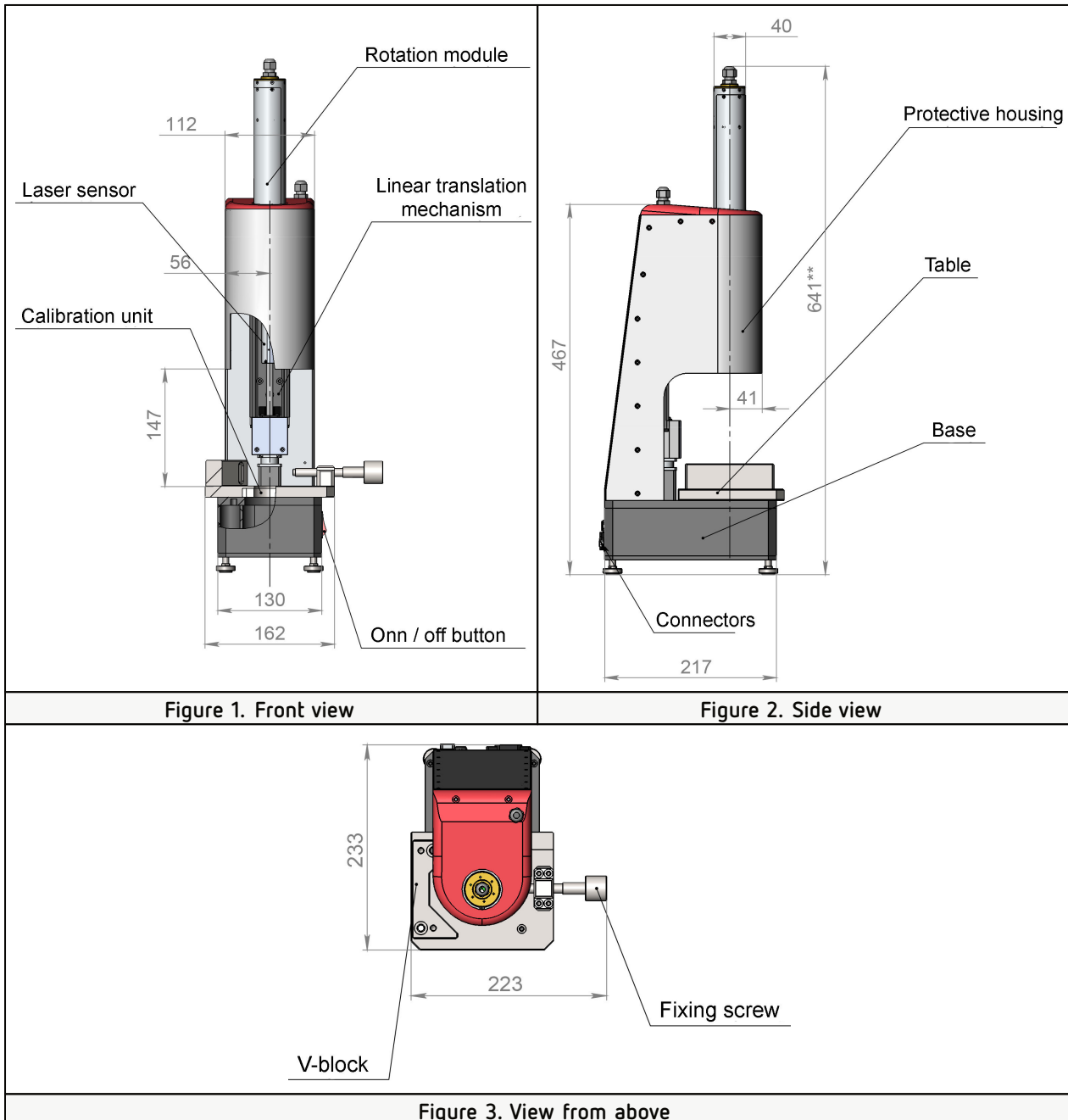

The machine operates as follows:

A leaf spring must be installed onto the table and fixed in the V-block by the fixing screw. On the operator's command, a laser sensor moves into the control hole. Rotating laser sensor scans the inner surface of a leaf spring, and the system transmits polar coordinates of the surface (distance from the rotation axis measured by the sensor and a corresponding angle of rotation) to the PC for calculating the required geometric parameters. The depth of control and number of measured cross sections are defined by the software.

## 8. Connection

- Connect the machine to your PC by means of two cables (Ethernet cable and RS485 cable).
- Connect the power cable to the rotation module (this power cable is mounted on the machine housing).
- Connect the machine to 220V AC by using the special power cable. All cables are shipped with the machine.

## 9. Network setting

The machine is shipped with the following default network configuration:

IP address: 192.168.0.3.

It is imperative to configure the network card of the PC in the following address space: 192.168.0.X.

## 10. Intended use

### 10.1. Preparation for use

- Check the condition of output window of laser sensor and, if necessary, wipe it with a soft cloth.
- Rotate a laser sensor by hand and check smooth progress.
- Check the cables and power supply.
- Make sure that the network settings are correct.
- Switch on the machine.
- Run a service program.
- Perform the calibration procedure (for the first use).

When you have done all the steps listed above, you can start the measurement procedure. How to install the springs properly, see in the next topic.

### 10.2. How to install a leaf spring

Depending on the spring size, there are four ways to install it on the table.

To install a leaf spring 1, it is necessary to place it on the table tight to the V-block, and to fix it by the fixing screw (Figure 4).

To install the smaller leaf springs (# 2, 3, 4), you need to use special liners as shown on Figures 5, 6, 7. Liners are supplied with the machine.

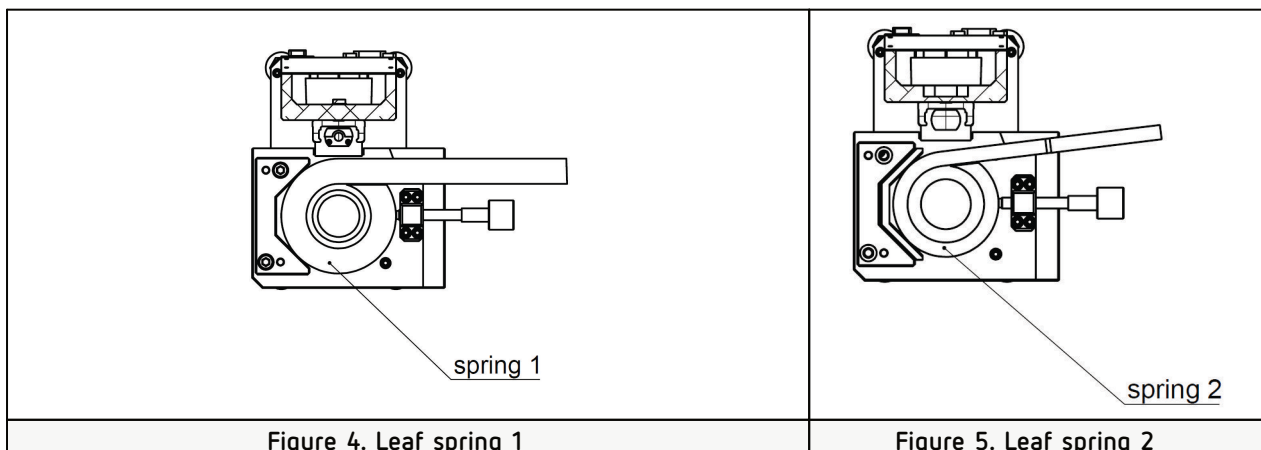

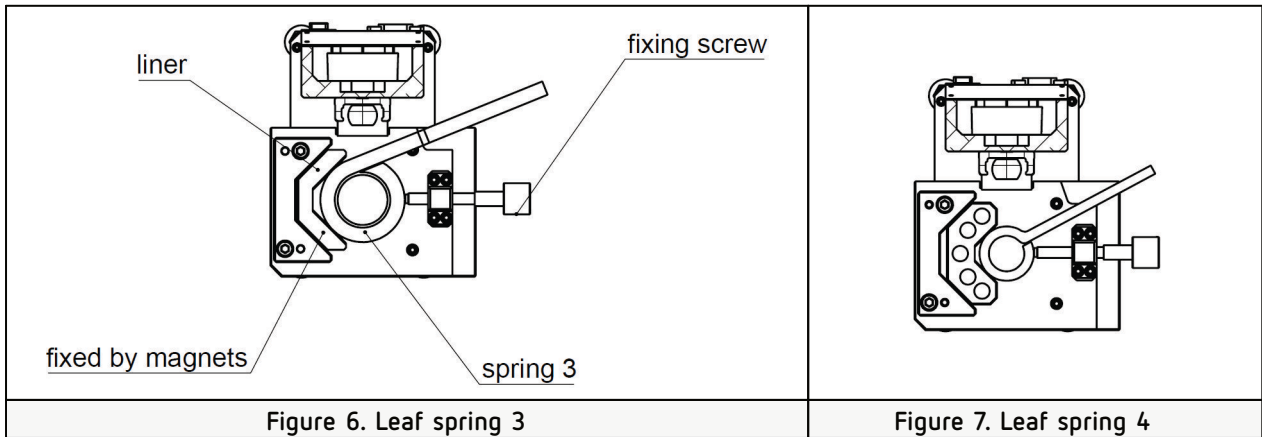

## 11. Service program

### 11.1. System requirements

Operating system Windows 7 and later.

Microsoft Visual C++ Runtime Redistributable for Windows 64-bit.

Shipped with the package (you need to run `vcredist_x64.exe`).

### 11.2. Running the program

To run the program, you need to double-click on the executable file - `idm.exe`.

### 11.3. Authorization

After you run the program, you need to log in:

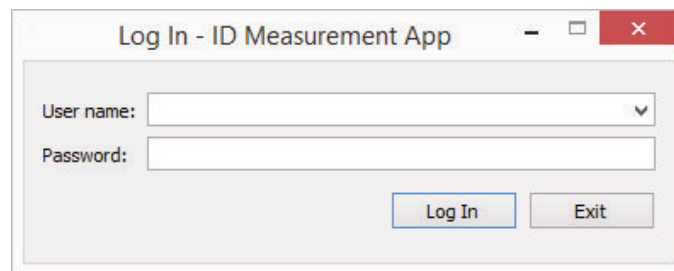

- Enter the user name (by default - Admin).
- Enter the password (by default - Admin).
- Click the Log In button.

How to create a new account, or how to edit a current account, see p. 11.5.2.

## 11.4. Main window

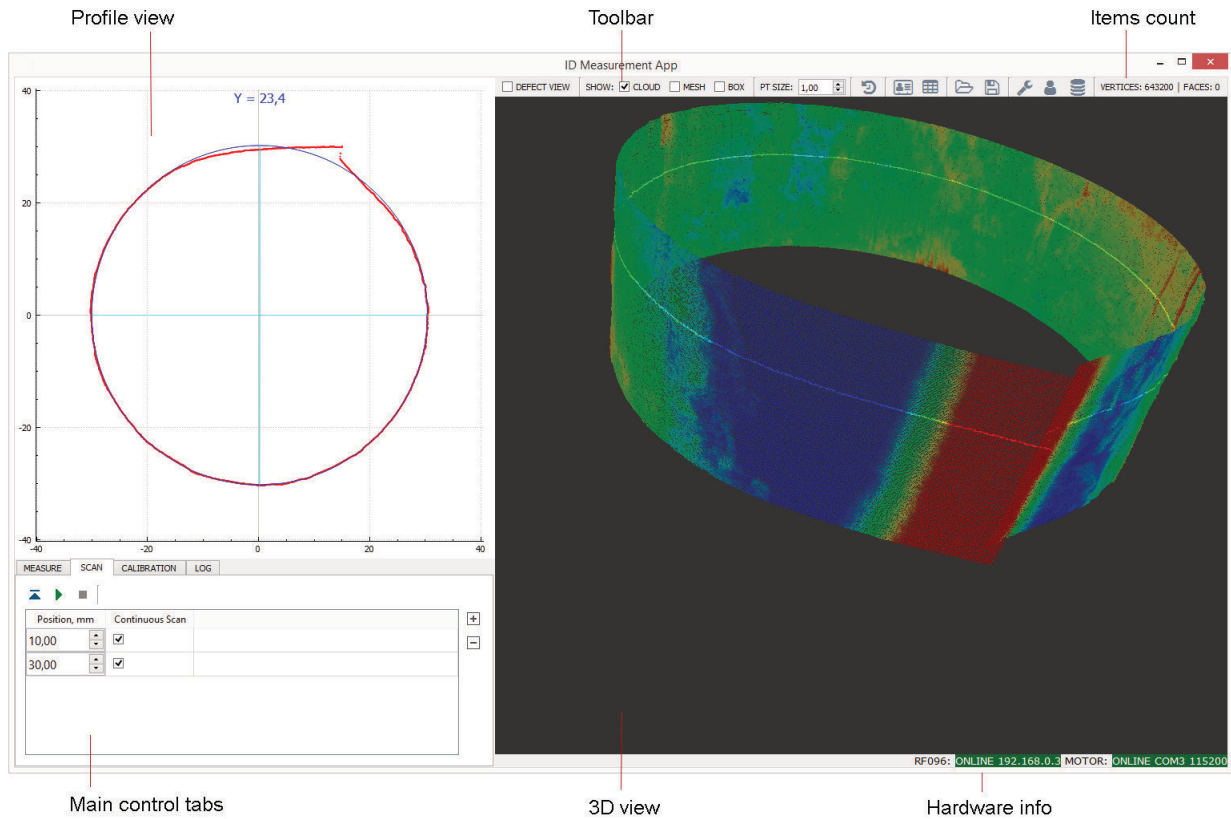

### Main control tabs:

Tab	Description
Measure	Calculated parameters for selected profile / whole scan.
Scan	Scan settings and scan process control.
Calibration	System calibration.
Log	Program log.

### Toolbar:

Element	Description	
DEFECT VIEW	Toggle the profile / defect view. The defect view mode is intended to show the profile deviations in depth.	
SHOW:	CLOUD	Switch on / off the display of point cloud.
	MESH	Switch on / off the view of triangle mesh built from a point cloud (press Ctrl key to rebuild mesh).
	BOX	Draw a scale box.
PT SIZE	Change a point size for a point cloud.	
	History of measurements.	
	Session window.	
	Open the report in Excel.	
	Import a point cloud / mesh from an external file.	
	Export a current cloud / mesh / profile to an external file.	
	Scan and hardware settings, information about the program.	
	Account management window.	
	Connection window.	



## 11.5. Settings

### 11.5.1. "Settings" window

#### 11.5.1.1. "SCAN" tab

Click  in the toolbar. The SCAN tab:

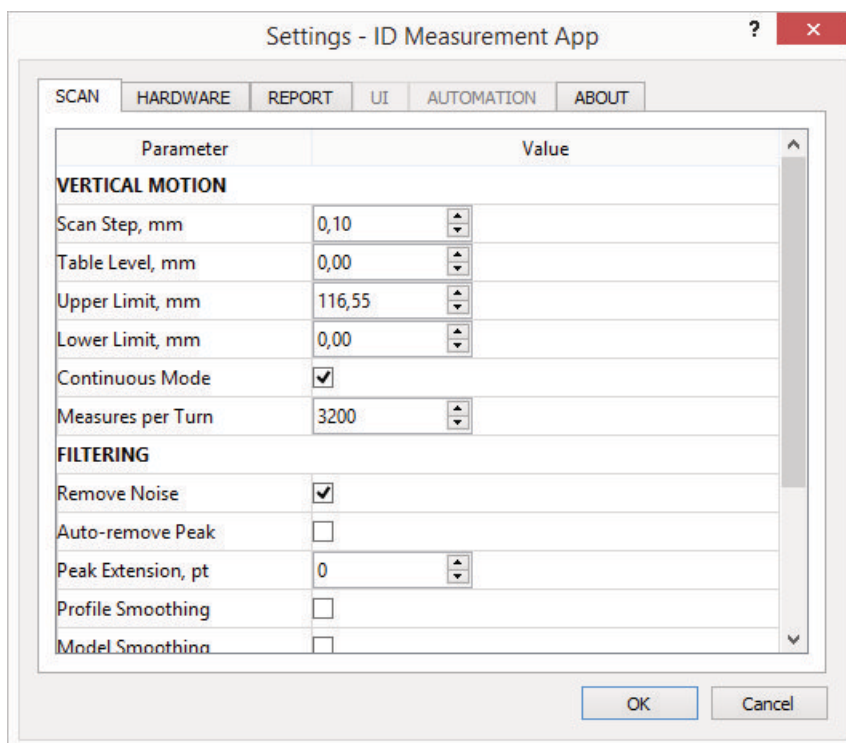

#### VERTICAL MOTION:

Parameter	Description
Scan Step, mm	Scan step for Continuous Mode.
Table Level, mm	Height where a top of table surface located.
Upper Limit, mm	Upper limit of the vertical motion of the linear translation mechanism. The maximum value is 116.55.
Lower Limit, mm	Lower limit of the vertical motion of the linear translation mechanism.
Continuous Mode	Default and recommended mode of scanning. Uncheck to switch to turn-per-step mode in case of troubleshooting. In addition, turn-per-step mode may be preferable in case of discrete scan.
Measures per Turn	Number of points per single profile. Maximum and default value is 3200. Change to lower value in order to lower memory consumption. In addition, it makes sense to use lower values on bigger scan step to make a point cloud uniform.

#### FILTERING:

Parameter	Description
Remove Noise	General noise removal filter (recommended to always be turned on).
Auto-remove Peak	Program guesses the peak location to remove it from scan. It is experimental feature that works fair on a clear surface only. Manual peak set is recommended.
Peak Extension, pt	Enable a filter to remove extra points from both sides (number of points).

Parameter	Description
Profile Smoothing	Apply a smooth filter on each profile. Recommended to use only on discrete scans (it's not good on whole point cloud).
Model Smoothing	Apply parameters of model smoothing (UPRc and Lc).
UPRc	The maximum allowable number of undulations per one revolution. The range of values: 0...3200 (number of points). The default value is "50". The less the value, the more smoothed the profile will be. If the value is "0", the profile will be completely smoothed.
Lc, mm	The size of the surface roughness to be smoothed (in vertical direction). The default value is "4". If the value is "0", the profile will not be smoothed.

**CALIBRATION:**

Parameter	Description
Calibration Method	Calibration method: Sample - calibration using the calibration unit; Embedded - calibration using the embedded calibration detail.

To save the changes, click OK.

**11.5.1.2. "HARDWARE" tab**

Hardware settings must remain unchanged and may be overridden only in case of firmware upgrade.

Click in the toolbar and go to the **HARDWARE** tab:

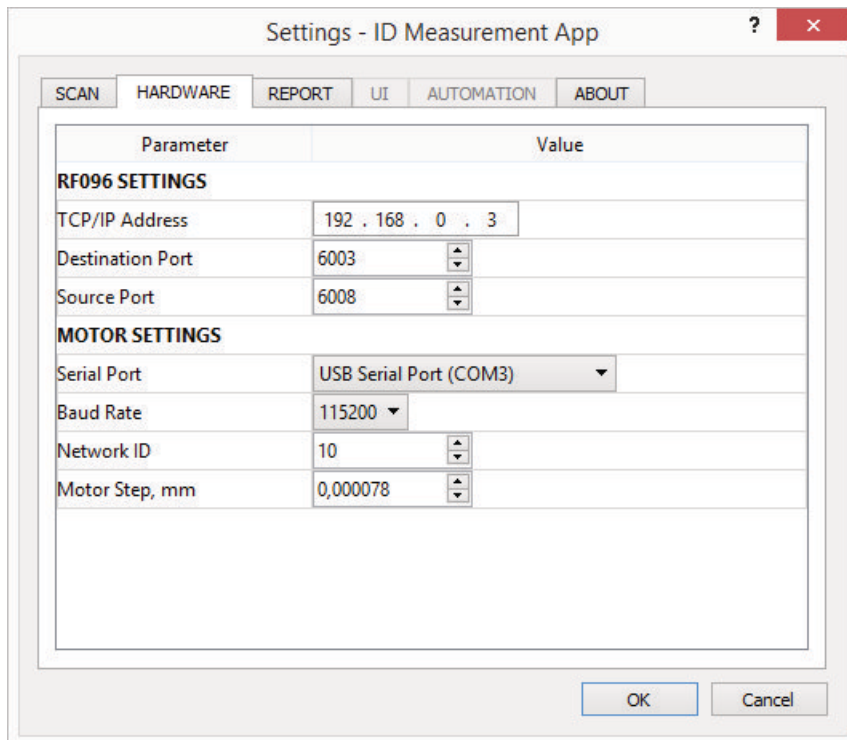

**FDRF096 SETTINGS:**

Parameter	Description
TCP/IP Address	TCP/IP address of FDRF096 (IP address of your PC must be in the same subnet).
Destination Port	Ports used for communication with FDRF096.
Source Port	

### MOTOR SETTINGS:

Parameter	Description
Serial Port	Serial port of the motor (COM on Windows).
Baud Rate	Baud rate of the motor.
Network ID	Network ID of the motor.
Motor Step, mm	Motor step in millimeters.

To save the changes, click **OK**.

#### 11.5.1.3. "REPORT" tab

Click  in the toolbar and go to the **REPORT** tab:

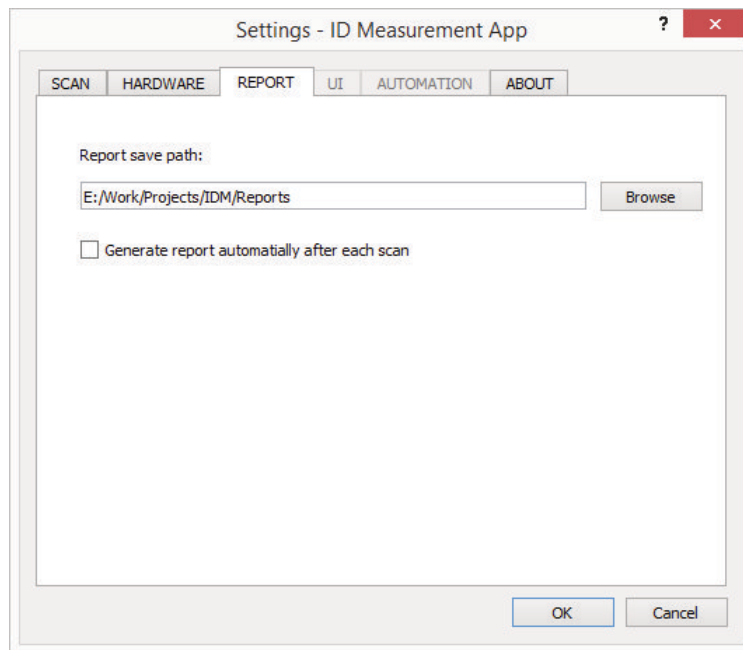

Click **Browse** and specify a path to the directory where the reports will be stored.

To generate the reports automatically after each scan, select **Generate report automatically after each scan**.

To save the changes, click **OK**.

### 11.5.1.4. "ABOUT" tab

Click  in the toolbar and go to the ABOUT tab:

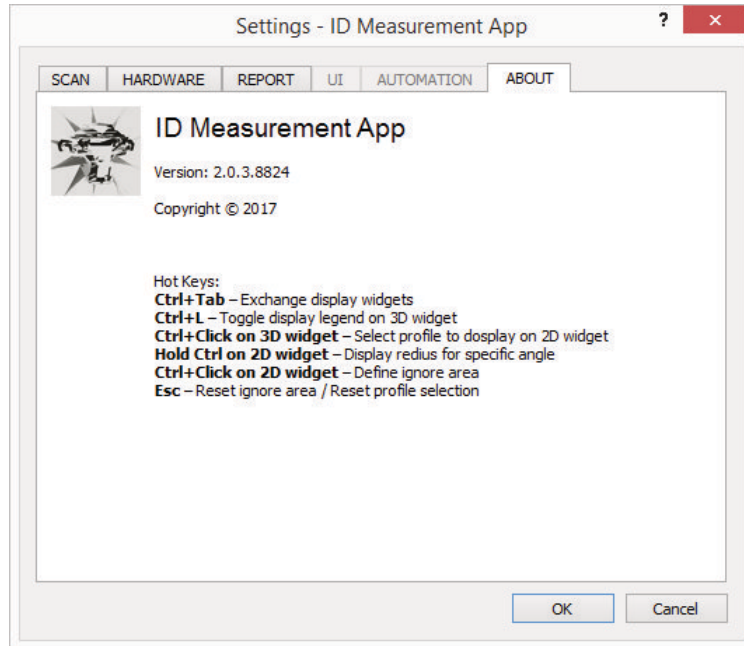

In this tab, you can find a software version, website of the device manufacturer, and a list of hot keys.

For more information about hot keys, refer to p. 11.8.

### 11.5.2. "User Management" window

#### 11.5.2.1. "My Account" tab

Click  in the toolbar. The My Account tab:

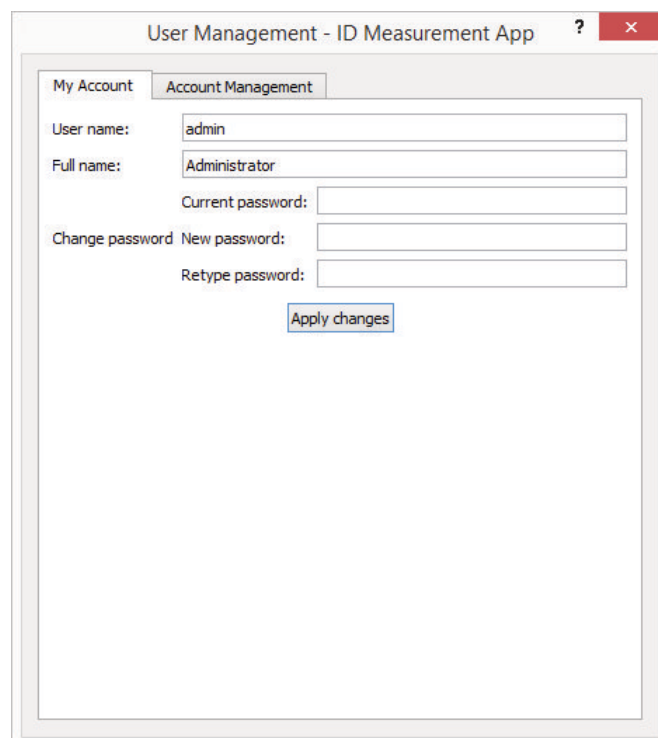

The **My Account** tab displays a name of the current account and a full name of the user. To change a password, you need to follow the steps below:

- Enter the current password in the **Current password** field.
- Enter the new password in the **New password** field.
- Retype the new password in the **Retype password** field.

To save the changes, click **Apply changes**.

### 11.5.2.2. "Account Management" tab

Click  in the toolbar and go to the **Account Management** tab:

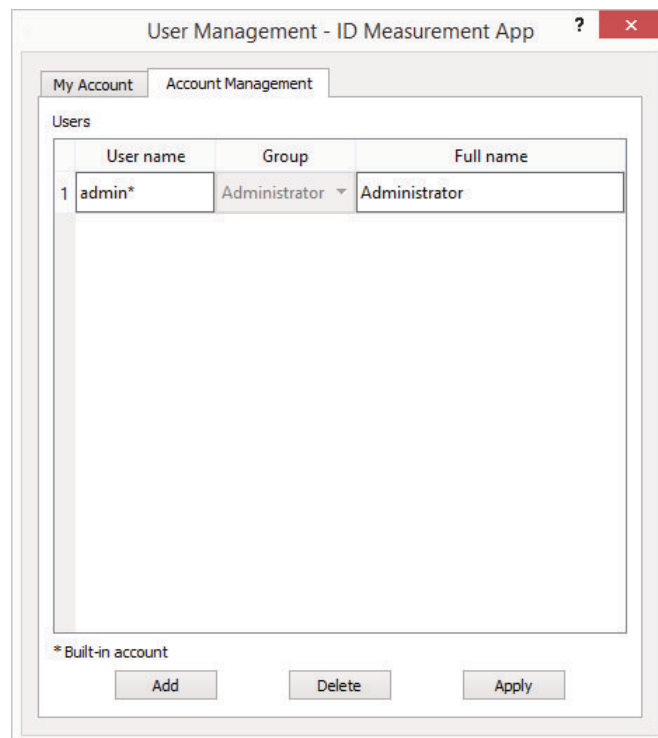

In the **Account Management** tab, you can add, edit, or delete the accounts.

To add a new account:

- Click **Add**.
- Enter the account name in the **User name** field (this name will be used to log in).
- Select a group from the **Group** list: Administrator or Operator.
- Enter a full name of the user in the **Full name** field.
- Click **Apply**.
- In the emerged dialog box, set the password for the new account: enter the password in the **Password** field, then retype it in the **Retype password** field, and click **Ok**.

To edit the account:

- Edit the account (**NOTE**: only the group and the full name can be changed).
- Click **Apply**.

To delete the account:

- Place the cursor in the **Full name** field.
- Click **Delete**.

### 11.5.3. "Connection" window

Click  in the toolbar. The Connection window:

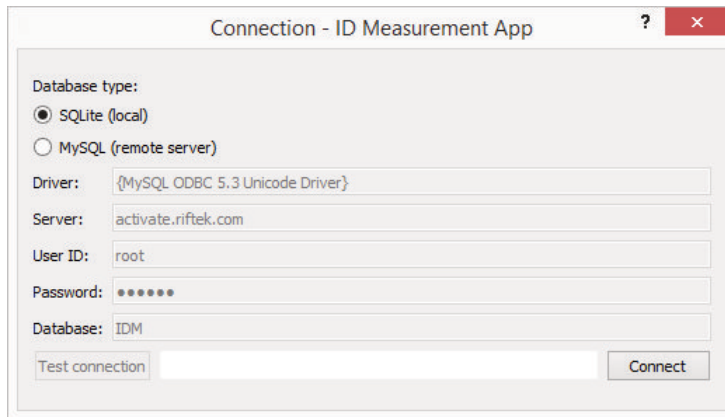

By default, a local database is selected (SQLite).  
 If you select MySQL, you need to perform the setting procedure:

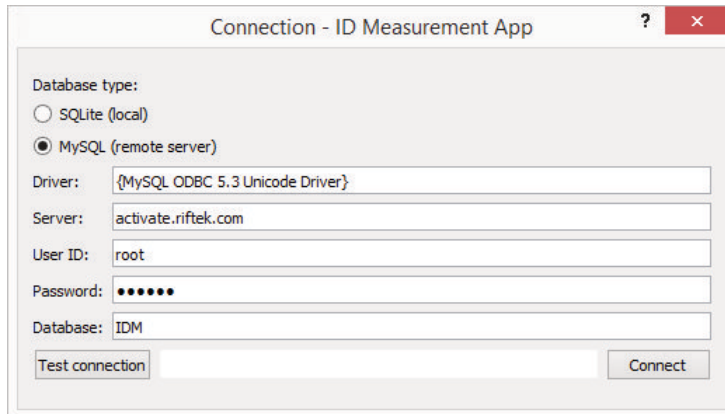



### 11.6. Calibration

 The calibration procedure must be done once before you start to use the machine. You may recalibrate it in case of significant changes to the environment.

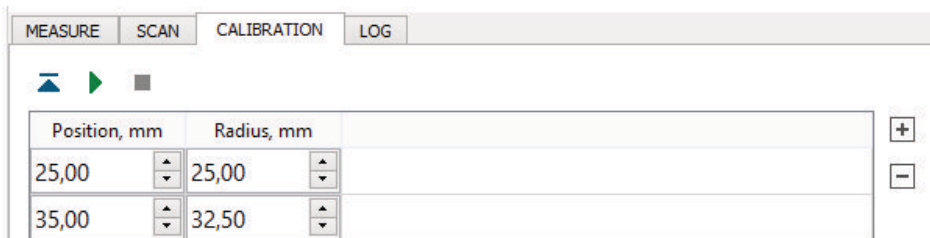

The calibration is performed using the embedded calibration detail.  
 The calibration parameters are preset in the program and must not be changed:



Buttons assignment:

Button	Description
	Start the calibration process.
	Stop the calibration process.
	Lift up the sensor.

To perform the calibration procedure, follow the steps below:

- Click  in the toolbar.
- In the **SCAN** tab, select **Embedded** for the **Calibration Method** parameter, and click **OK**.
- Close the **Settings** window.
- Click .

Upon successful calibration, you will see the following:

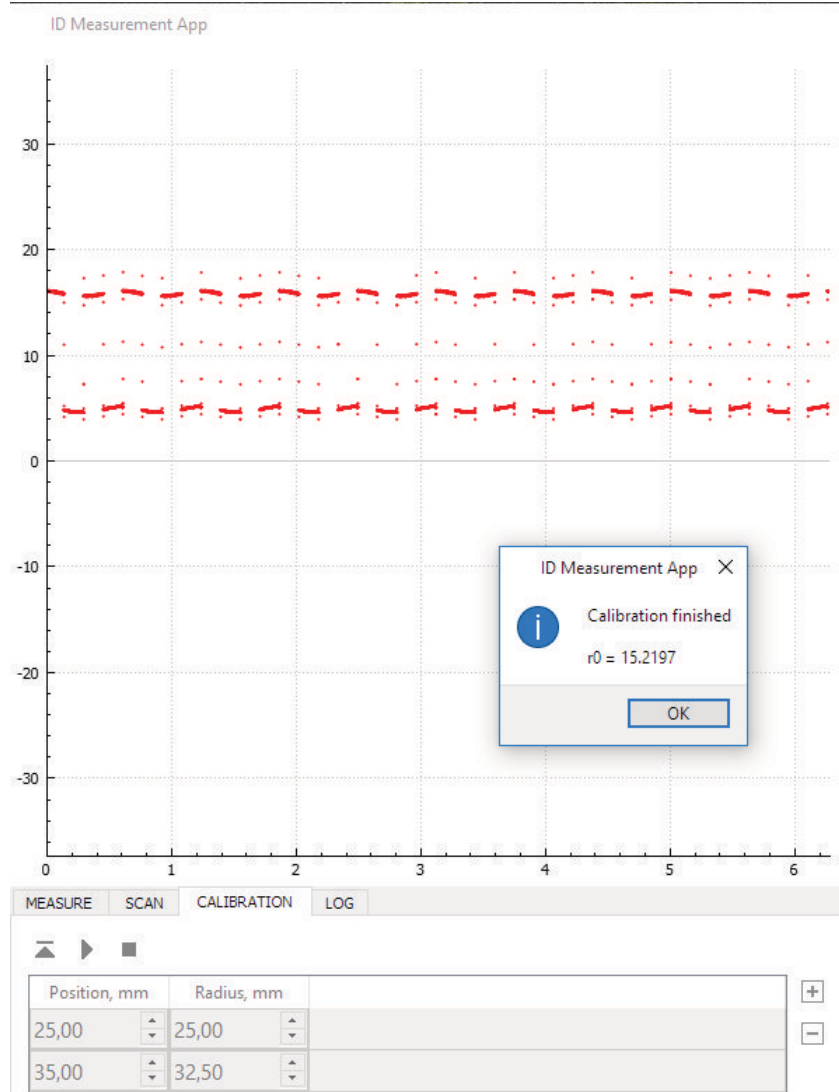

## 11.7. Measurement

### 11.7.1. Scan session

The Session window appears immediately after authorization.

Measurement	Normal value	Tolerance -	Tolerance +
<input checked="" type="checkbox"/> Average Diameter	60,42	0,02	0,02
<input checked="" type="checkbox"/> Minimal Diameter	58,48	0,02	0,02
<input checked="" type="checkbox"/> Maximal Diameter	67,21	0,02	0,02
<input checked="" type="checkbox"/> Cylindricity	4,59	0,02	0,02
<input checked="" type="checkbox"/> Roundness	3,97	0,02	0,02
<input checked="" type="checkbox"/> Taper	0,00	0,02	0,02

The Session window can be opened by clicking  in the toolbar. In this window, the user should:

- Create the session description by populating the fields in the left side;
- Customize a list of measurements:
  - o Tick the parameters you need to measure;
  - o Set the nominal values and tolerances.

To save the changes, click **Save and Proceed**.



After typing the value in the field, you need to press the Enter key, otherwise this value will not be saved.

### 11.7.2. Scanning

#### 11.7.2.1. Creating the scan program and starting the scanning process

When you have created the scan session, it is necessary to create the scan program. Each program step must be entered to the table:



Position, mm	Continuous Scan
10,00	<input checked="" type="checkbox"/>
40,00	<input checked="" type="checkbox"/>

**Position** – height to move to in millimeters (relative to the table surface). To add the scan position, click **+**. To remove the scan position, put the cursor in the empty field to the right of the selected position, press the left mouse key, and then click **-**.



**Continuous Scan** – trigger to take a series of profiles from this position to the next one. The step can be customized in the "Settings" window, the "SCAN" tab (see p. 11.5.1.1.). When it is unchecked, a single profile will be taken and then a sensor will be moved to the next position.

Buttons assignment:

Button	Description
	Start the scanning process.
	Stop the scanning process.
	Lift up the sensor.

When you have created the scan program, install a leaf spring onto the table as described in p. 10.2. and click  in order to start the scanning process.

### 11.7.2.2. Ignore area

During the scan process or right after it, you may select the defective area to exclude it from calculation (hereinafter - the ignore area). You may select only one such area. In order to select the ignore area, hold the Ctrl key pressed and click the left mouse key on the profile in two different positions to cover the defective area (see the screen shot below). To reset the ignore area, press the Esc key.

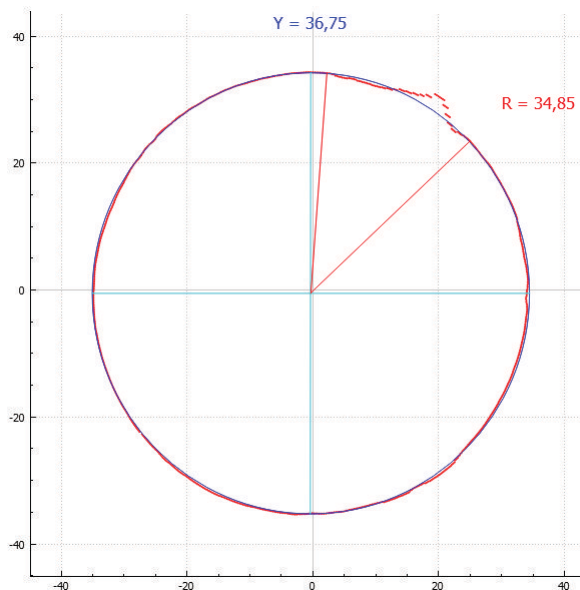

The ignore area of the selected profile will be green (in Profile View).

### 11.7.2.3. 3D view

When you run the scanning process, the software starts to construct the 3D model of the object.

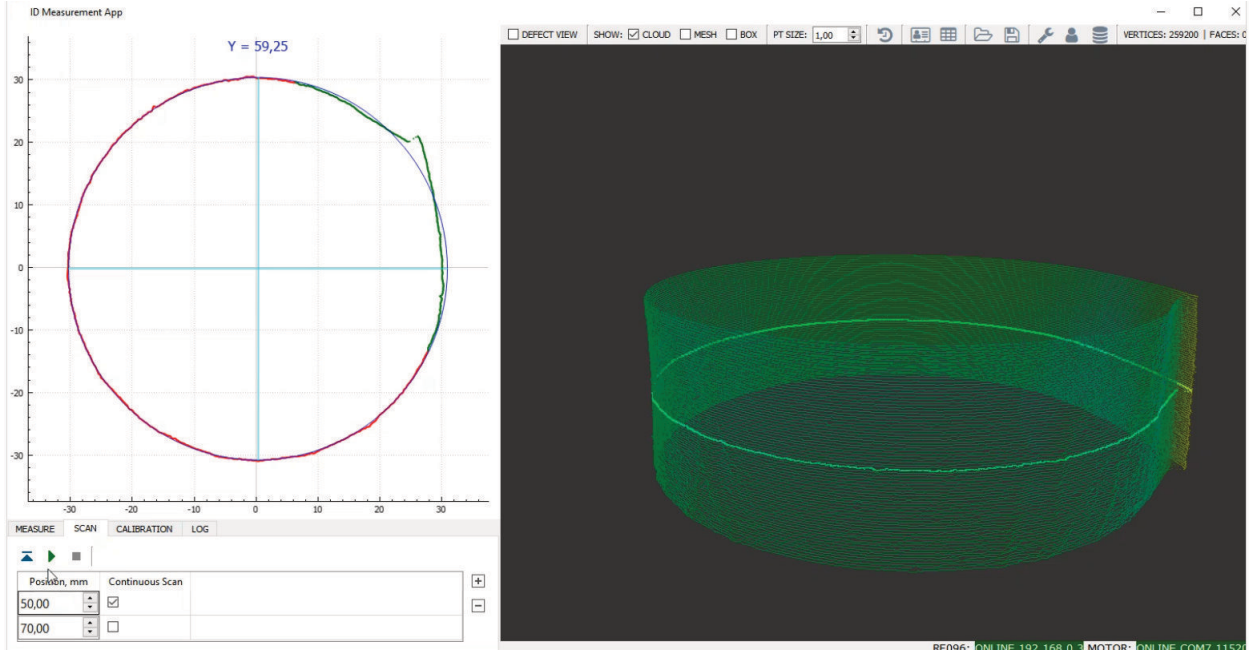

To select a profile to view in the Profile View mode, hold the Ctrl key pressed and click the left mouse key on the profile. In the 3D View mode, the selected profile will be highlighted.

To construct the mesh model, tick the **MESH** box in the toolbar:

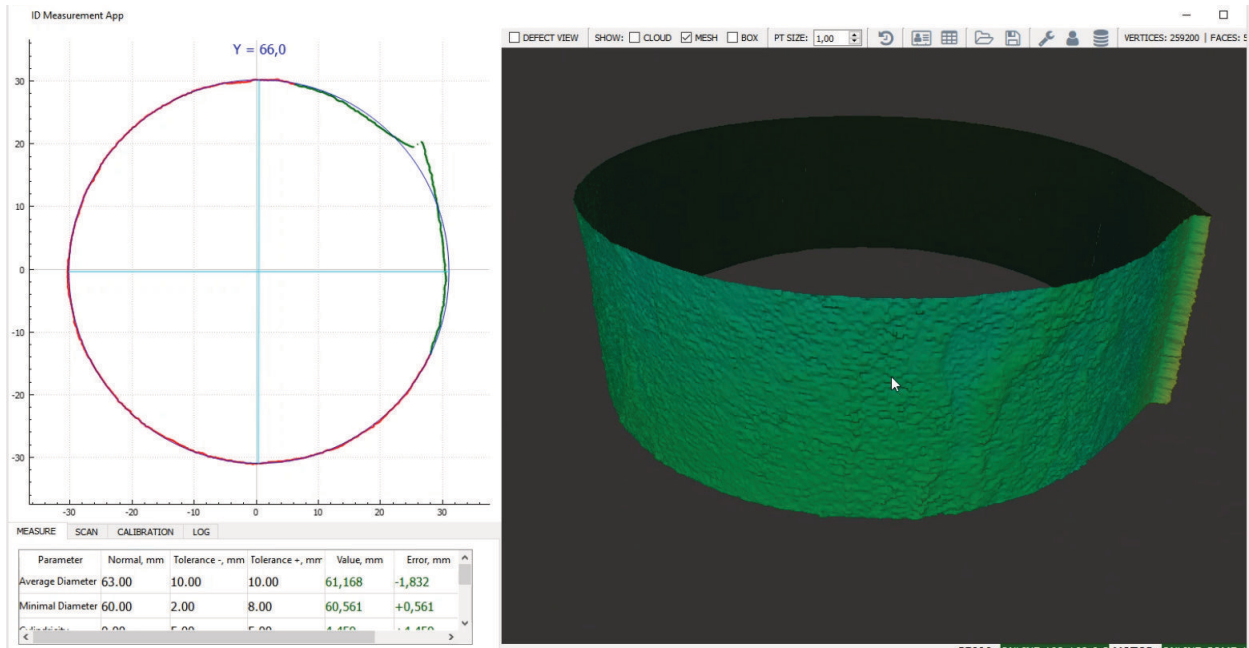

To browse the measured values, go to the **MEASURE** tab.

### 11.7.2.4. Profile view

Profile View is the detailed view of selected profile in a point cloud model. How to select a profile, see in the previous topic.

To view the profile deviations in depth, tick the DEFECT VIEW box in the toolbar.

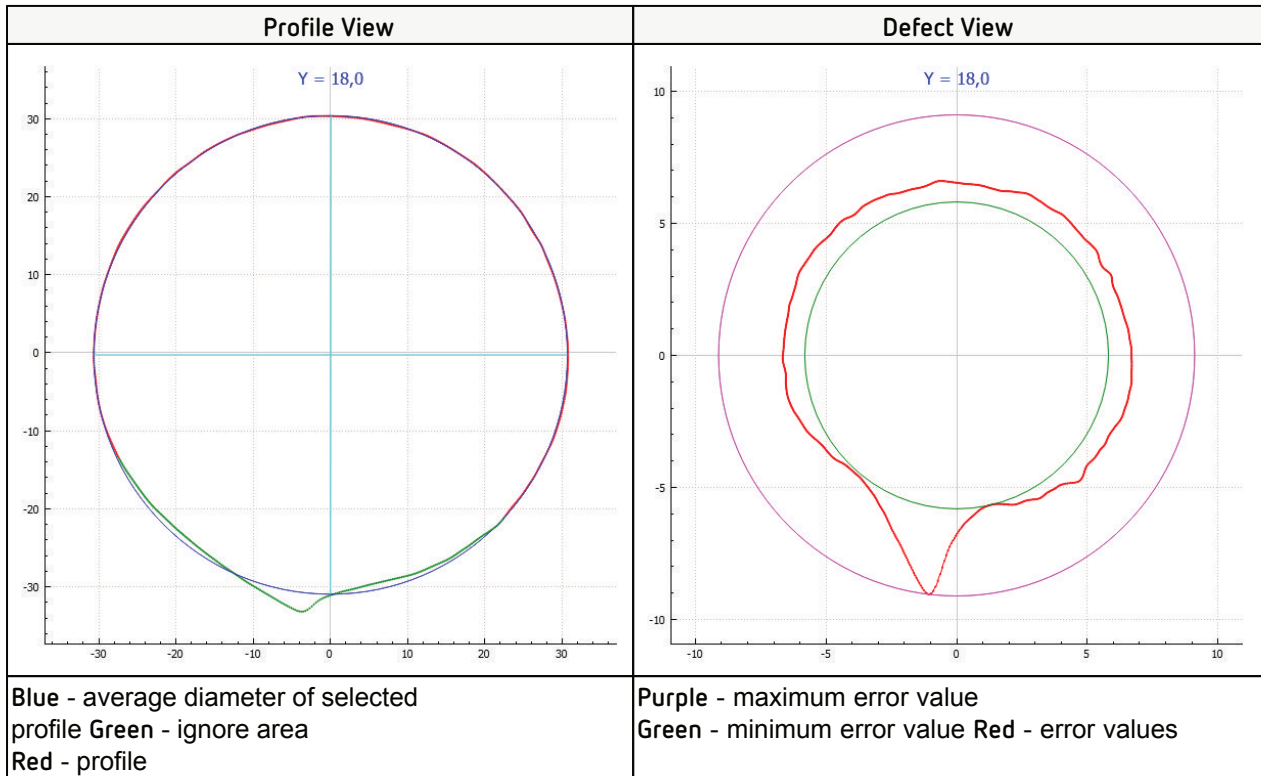

To view the radius, hold the Ctrl key pressed and put the cursor on the profile.

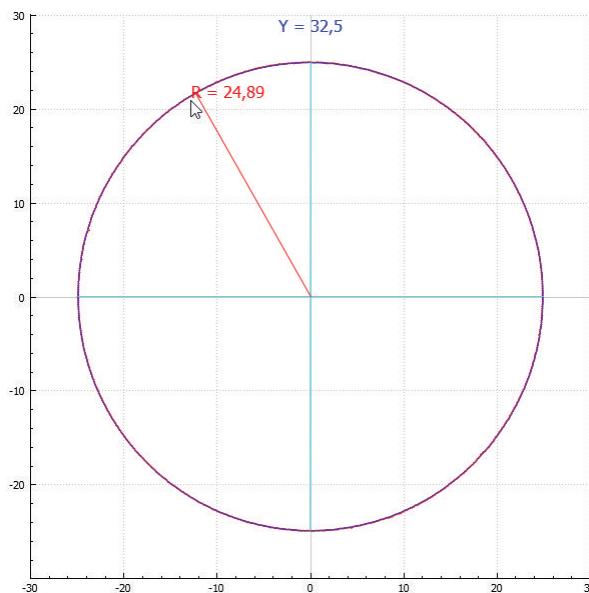

To view the measured values for selected profile, go to the MEASURE tab. You can exchange the Profile View and 3D View by pressing Ctrl +Tab.

You may zoom profiles (both in 3D View and Profile View) by rotating the mouse wheel, and you may move them by pressing the left mouse key. To reset these actions, you need to double-click on the area (Profile View or 3D View).

To browse the measured values for the selected profile, go to the MEASURE tab.

Parameter	Normal, mm	Tolerance -, mm	Tolerance +, mm	Value, mm	Error, mm
-----------	------------	-----------------	-----------------	-----------	-----------

The measured value will be displayed in the Value field. The deviation from the normal value will be displayed in the Error field. If the error value doesn't exceed the tolerances, it will be displayed in green color, otherwise - in red color.

To select a profile, hold the Ctrl key pressed and click the left mouse key on the profile in the 3D View area.

To browse the history of measurements, click in the toolbar:

Date	Time	User	Plant	Area	Line	Part Number	Product Order	Go?
12.06.2018	14:34:53	Administrator	M1	Previas	1	PN001	PO001	No
12.06.2018	17:20:58	Administrator	M1	Previas	1	PN001	PO001	No
12.06.2018	17:25:15	Administrator	M1	Previas	1	PN001	PO001	No
14.06.2018	12:43:49	Administrator	M1	Previas	1	PN001		No
14.06.2018	13:52:47	Administrator	M1	Previas	1	PN001	PO003	No
27.06.2018	11:01:32	Administrator	M1	Previas	1	PN001		No

You can filter the data: type the word or number in the Filter field and press Enter.

To open the scan report, click in the toolbar. For more information, refer to p. 11.5.1.3.

To export data to external file, click in the toolbar. Supported file formats: ASC, STL, IDM, CSV.

To import data from external file, click in the toolbar. Supported file formats: ASC, STL, IDM.

## 11.8. Hot keys

Ctrl + L	Hide / show the legend bar in "3D View".
Ctrl + Tab	Exchange the "Profile View" and "3D View".
Ctrl + click on "3D View"	Select a profile to display in "Profile View".
Ctrl + click on "Profile View"	Define the ignore area.
Hold Ctrl key on "Profile View"	Display the radius.
Esc	Reset the ignore area / Reset the profile selection.

## 12. Technical support

Technical assistance related to incorrect work of the machine and to problems with a service program is free. Requests for technical assistance should be addressed to [sales@althen.nl](mailto:sales@althen.nl) or by phone +31 (0)70-392 4421.

## 13. Warranty policy

Warranty assurance for the Leaf Spring Hole Inner Diameter Measurement Machine FDRF096-30/75-120 Model - 24 months from the date of putting in operation; warranty shelf- life - 12 months.

## 14. List of changes

Date	Version	Description
17.04.2017	1.0.0	Starting document.
27.06.2018	2.0.0	The following sections were updated: <ul style="list-style-type: none"> <li>· Basic technical data</li> <li>· Structure and operating principle</li> <li>· Service program</li> </ul>