

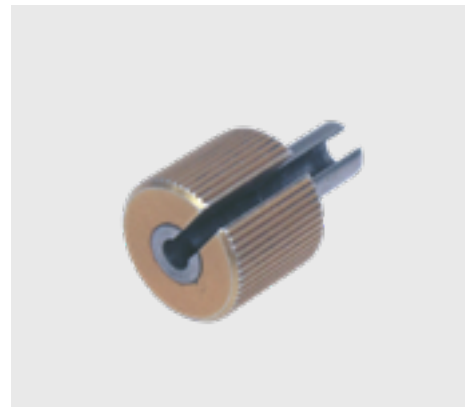

Scanivalve

PNEUMATIC CONNECTOR, TUBING, & ACCESSORY CATALOG

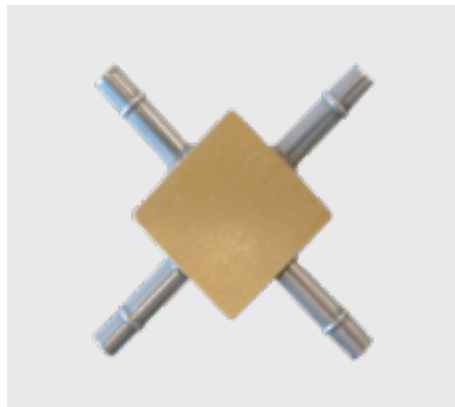
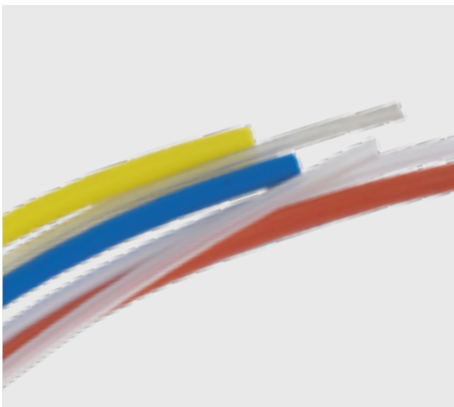

Your expert partner in sensors & controls

ÜBER ALTHEN SENSORS & CONTROLS

Althen Sensors & Controls steht für wegweisende Mess- und Sensoriklösungen. Wir stellen uns jeder messtechnischen Herausforderung. Immer auf der Suche nach Innovationen geben wir uns erst zufrieden, wenn wir die perfekte Lösung für Ihre Messaufgabe gefunden haben. In unserer hauseigenen Fertigung entstehen so kundenspezifische Systemlösungen. Althen ist Partner vieler anerkannter Universitäten und führender Konzerne. Wir stehen in einem intensiven Wissenstransfer und entwickeln gemeinsam die Technologien der Zukunft. Als eines der ersten Unternehmen in unserer Branche wurde Althen gemäß TÜV PROFICERT-Verfahren von der Zertifizierungsstelle des TÜV Hessen nach DIN EN ISO 9001:2015 zertifiziert.

UNSERE DIENSTLEISTUNGEN FÜR SIE

Sie stehen vor einer messtechnischen Herausforderung oder benötigen ein passendes Ersatzteil für Ihre Anwendung? Unsere Spezialisten beraten Sie – ausführlich und fachgerecht. Dabei behalten wir Ihre Kosten im Blick und entwickeln bei Bedarf kundenspezifische Sonderlösungen. Profitieren Sie von unserer langjährigen Erfahrung auf dem Gebiet der Messtechnik und Sensorik:

 **Hochwertige Fertigung**

 **Messung und Vermietung**

 **Kalibrierung von Messgeräten**

 **Schulungen**

INHALT

PLASTIC TUBING	5
- Nylon Tubing	
- Teflon Tubing (Clear)	
- Vinyl Tubing (Clear)	
- Urethane Tubing (Clear)	
PLASTIC TUBING SPECIFICATIONS	6
TUBING CLAMPS AND SEALANT	7
- Helical Tubing Clamps	
- Pipe Sealant	
TUBULATIONS AND SPECIALIZED TUBING TOOLS	8
- Bulged Stainless Steel Tubulations	
- Tubing Push on Tool	
SPECIALIZED TUBING TOOLS	9
- NYCLMP Screw-Back Tool	
TUBE/PIPE CONNECTORS	10
- Pipe Connectors	
- Tube Adaptors for X-Lok Compression Fittings (1500psi)	
X-LOK ADAPTORS	11
- X-Lok to Tubulation	
- Tube Inserts for X-Lok Compression Fittings 7	
PRESSURE TAPS AND PATCH	12
- Pressure Tap	
- Pressure Patch	
PNEUMATIC CONNECTORS	13-18
- Quick Disconnect (50-100psi)	
- Model D (300psi)	
- 24C, 48C, and 64C	
- 24C Pneumatic Connectors (500psi)	
- 48C Pneumatic Connectors (500psi)	
- 64C Pneumatic Connectors (100psi)*	
- ZOC (500psi)	
- 32MPS (100psi)	
- 70MPS (500psi)	
PNEUMATIC CONNECTORS - HIGH PRESSURE	19
- Model L (1500psi)	
RECTANGULAR CONNECTORS	20-21
- RC2 (300psi)	
- RPC (100-500psi*)	
PNEUMATIC MANIFOLDS (500PSI)	22
TUBE CONNECTORS 19	23
QUICK COUPLERS 20	24
PNEUMATIC CALIBRATION/PURGE VALVE	25





E-RAD4000 REMOTE A/D OPERATION

Scanivalve stocks clear plastic tubing for many applications including:



- Wind Tunnel Tests
- Flight Tests
- Gas Turbine and Diesel Tests
- R&D and Laboratory Use
- Industrial Test

Available stock materials are urethane, Nylon, vinyl and Teflon. Sizes are available to fit over .031 inch through .125 inch tubulations. Tubing is sold by the spool.

NYLON TUBING

This tubing is rated at 110°C* and is ideal for gas turbine testing. It fits snugly over our stainless steel tubulations and can be used without helical tubing clamps to 100 psi, or up to 1500 psi (burst pressure NYLN-063) with helical tubing clamps and sealant. As a special order, NYLN-125HW can be ordered in a variety of colors.

VINYL TUBING (CLEAR)

This tough, lightweight tubing carries a 65°C* rating. It fits snugly over our stainless steel tubulations, and can be used with or without our helical tubing clamps. It can be used for short duration tests up to 30 psi without helical clamps. Size .063 vinyl tubing has a recommended working pressure of 90 psi at 21°C.

TEFLON TUBING (CLEAR)

This chemically inert tubing is rated at 260°C*. It uses the same helical tubing clamps as the Nylon tubing. Size .063 Teflon tubing has a recommended working pressure of 500 psi at 21°C.

URETHANE TUBING (CLEAR)

Urethane tubing has a temperature rating of 95°C*. It is ideal for low pressure tests in wind tunnel models. The tubing is extremely flexible, resilient, and resistant to kinking. It fits snugly over our stainless steel tubulations and is resistant to weather, tearing, abrasion and impact. Size .063 urethane has a recommended working pressure of 100 psi at 21°C.

TUBING MATERIAL SIZES TYPICALLY STOCKED

For use on:	Vinyl	Nylon 6/6 (Clear)	Urethane	Teflon (PTFE)
.031 Inch (0.79mm) O.D. SS tubulation			URTH-031 (I.D.)	
.040 Inch (1.02mm) O.D. SS tubulation	VINL-040 (I.D.)	NYLN-040† (I.D.)	URTH-040 (I.D.)	TFLN-040 (I.D.)
.063 Inch (1.59mm) O.D. SS tubulation	VINL-063 (I.D.)	NYLN-063 (I.D.)	URTH-063 (I.D.)	TFLN-063 (I.D.)
.125 Inch (3.18 mm) O.D. SS tubulation	VINL-125**† (I.D.)	NYLN-125HW (I.D.)		TFLN-125** (I.D.)

* Temperature ratings are referenced to atmospheric pressure of 14.7 psia nominal.

** Do not use this tubing in vacuum applications

† Indicates special order

O.D.= Outside Diameter; I.D. = Inside Diameter



PLASTIC TUBING SPECIFICATIONS

Part Number	I.D. Inches [mm]*	O.D. Inches [mm]	Recommended Working Pressure at 21°C PSI [kPa]	Burst Pressure at 21°C PSI [kPa]	Burst Pressure at 40°C PSI [kPa]	Max Operating Temperature °C [°F]	Min Operating Temperature °C [°F]	Burst Pressure at Max Operating Temperature PSI [kPa]	Minimum Bending Radius Inches[mm]	Spool Length Feet [Meters]
NYLN-063	.057 [1.45]	.089 [2.26]	1000 [6895]	1500 [10340]	1000 [6895]	110 [225]	-65 [-85]	800 [5515]	1.25 [31.75]	500 [152.4] 1000 [304.8]
NYLN-125HW	.117 [2.97]	.187 [4.75]	600 [4135]	1000 [6895]	750 [5170]	100 [212]	-65 [-85]	500 [3448]	1.75 [44.45]	250 [76.2]
TFLN-040	.036 [0.91]	.068 [1.73]	500 [3448]	700 [4825]	575 [3965]	260 [500]	-70 [-94]	70 [480]	0.50 [12.7]	500 [152.4]
TFLN-063	.053 [1.35]	.086 [2.18]	500 [3448]	700 [4825]	575 [3965]	260 [500]	-70 [-94]	70 [480]	0.75 [19.05]	500 [152.4]
TFLN-125	.106 [2.69]	.138 [3.51]	200 [1380]	350 [2415]	240 [1655]	175 [350]	-70 [-94]	50 [345]	1.25 [31.75]	300 [91.4]
URTH-031	.027 [0.69]	.051 [1.30]	125 [860]	375 [2585]	160 [1100]	95 [200]	-65 [-85]	70 [480]	0.188 [4.78]	500 [152.4]
URTH-040	.034 [0.86]	.066 [1.68]	125 [860]	350 [2415]	150 [1035]	95 [200]	-65 [-85]	70 [480]	0.25 [6.35]	500 [152.4]
URTH-063	.054 [1.37]	.086 [2.18]	100 [690]	250 [1725]	150 [1035]	95 [200]	-65 [-85]	50 [345]	0.25 [6.35]	500 [152.4]
VINL-040	.034 [0.86]	.066 [1.68]	100 [690]	400 [2760]	200 [1380]	65 [150]	-40 [-40]	35 [240]	0.32 [8.12]	500 [152.4]
VINL-063	.054 [1.37]	.086 [2.18]	90 [620]	250 [1725]	160 [1100]	65 [150]	-40 [-40]	35 [240]	0.50 [12.7]	500 [152.4]
VINL-125†	.106 [2.69]	.138 [3.51]	40 [275]	175 [1205]	50 [345]	65 [150]	-40 [-40]	35 [240]	0.63 [16.0]	500 [152.4]

* All I.D. tolerances are ±0.002" with the exception of TFLN tubing. All TFLN is ±0.003".
 † Special Order. Please consult factory.

■ HELICAL TUBING CLAMPS

These tubing clamps are used to clamp plastic tubing onto the stainless steel tubulations which extend from our Scanivalve modules and line of connectors, reducers, and manifolds. The brass clamps are designed to fit over our vinyl and urethane tubing on the tubulation. The stainless steel clamps are designed to fit over our Nylon and Teflon tubing. Clamps, tools, and tubing sizes are based on Scanivalve nominal stainless steel tubulation outside diameter. Actual dimensions of clamps, tools, and tubing may vary.



To Order, Specify		Brass		Stainless Steel
Stainless Steel Tubulation Size:	Scanivalve Tubing:	For use on Vinyl or Urethane tubing, #:	Scanivalve Tubing:	For use on Nylon or Teflon tubing, #:
.040 Inch [1.02mm] O.D.	VINL-040	CLMP-040	NYLN-040	NYCLMP-040
.063 Inch [1.59mm] O.D.	VINL-063	CLMP-063	TFLN-063 or NYLN-063	NYCLMP-063
.125 Inch [3.18mm] O.D.	VINL-125	CLMP-125	TFLN-125 NYLN-125HW	NYCLMP-125 NYCLMP-125HW

■ PIPE SEALANT

The use of sealant with the helical tubing clamps is recommended for pressures above 250 psi. It is best used on Nylon and Teflon tubing.

Application: Prior to tubing installation, lightly brush a small amount of sealant over the bulge of the stainless steel tubulation. Then drive the tubing and clamp onto the tubulation, using a small amount of twist to help spread the sealant. For high pressure applications, it is recommended that the SLNT2 is allowed to dry for 12-24 hours before full pressure is applied.



To order, specify as Scanivalve #SLNT2.

BULGED STAINLESS STEEL TUBULATIONS

Scanivalve manufactures a complete line of bulged stainless steel tubulations. The tubing is bulged on one end to ensure leak tight connections. Scanivalve’s plastic tubing and the brass or stainless steel helical tubing clamps fit over this bulge for a firm grip. It is recommended that the customer should epoxy the non-bulged end into their equipment. The tubulations are manufactured in lengths between 0.55 inches and 8.0 inches.



To Order, Specify: Scanivalve Part Number + Tubulation Length

Scanivalve Part Number:	Standard Tubulation Lengths Inches	Tubulation Size Inches [mm]
TUBN-040	.55, .75, 1.0, 2.0, 3.0, 4.0	.040 Inch [1.02mm] O.D.
TUBN-063	.56, .75, 1.0, 2.0, 3.0, 4.0	.063 Inch [1.59mm] O.D.
TUBN-125	.75, 1.0, 2.0, 3.0, 4.0	.125 Inch [3.18mm] O.D.

TUBING PUSH-ON TOOL

This tool is designed for use with vinyl, Nylon, Teflon and urethane tubing. The tool is used by grasping the tubing adjacent to the clamp (after the clamp has been screwed onto the tubing) and pushing it onto our standard stainless steel tubulations. It can also be used to push on tubing without clamps. Clamps, tools, and tubing sizes are based on Scanivalve nominal stainless steel tubulation outside diameter. Actual dimensions of clamps, tools, and tubing may vary.



To Order, Specify:	Approximate I.D. of tubing clamp Inches [mm]
TPOTL-031	.046 [1.17]
TPOTL-040	.059 [1.50]
TPOTL-063	.081 [2.06]
TPOTL-125	.136 [3.45]
TPOTL-125HW	.177 [4.50]

Model Tubulation Size

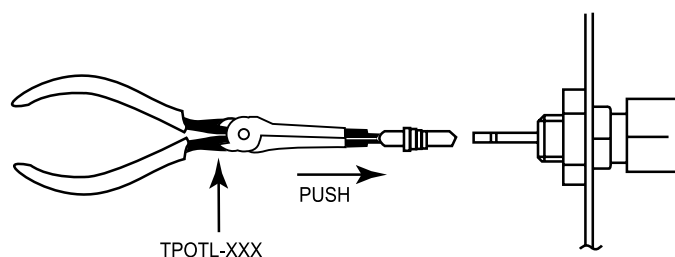



NYCLMP SCREW-BACK TOOL

The Nylon screw-back tool is designed to manually install the helical clamps over the bulge of the tubulation. The screw-back tool is slipped onto the tubing and used to push the NYCLMP towards the tubulation bulge until the bulge is engaged. By rotating the screw-back tool a few revolutions, it will screw the NYCLMP over the bulge. Continue turning the handle on the screw-back tool until the clamp is located 80% over the bulge (on the side of the bulge closest to the termination of the tubing).

The versatile long-handled version, NCSBTL3, is especially suited for installing the NYCLMPs in hard to reach areas.

The short-handled version, NCSBTL2 is used on panels where space is available.

Clamps, tools, and tubing sizes are based on Scanivalve nominal stainless steel tubulation outside diameter. Actual dimensions of clamps, tools, and tubing may vary.



To Order, Specify:

NCSBTL2-063
NCSBTL2-125
NCSBTL2-125HW
NCSBTL3-040
NCSBTL3-063
NCSBTL3-125
NCSBTL3-125HW

Model	Tubulation Size

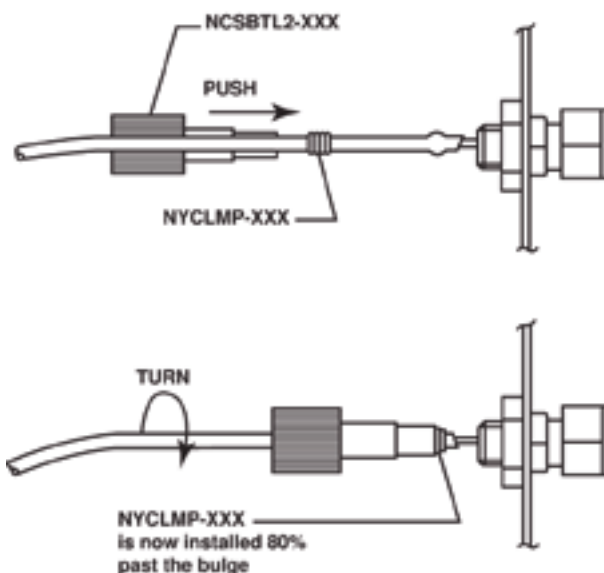

Note: When Heavy Walled (HW) tubing is used, specify the HW Screw-back tool listed in the table.



PIPE CONNECTORS

These connectors are useful to connect small diameter plastic tubing with larger 1/8 inch and 1/4 inch NPT threaded pipe. Sizes are governed by the NPT standard.

Tubulation sizes available: .031 (non-bulged), .040, .063, or .125 inch OD.

To Order, Specify:

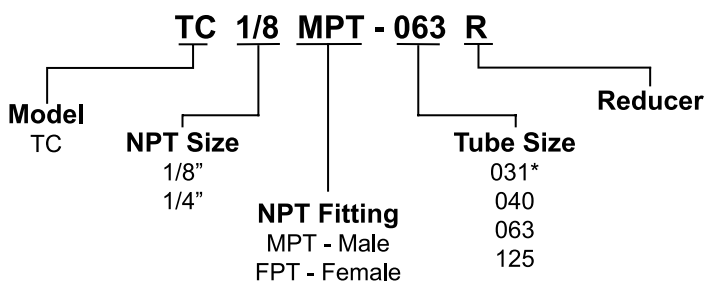

*.031 inch tubulations do not have a bulge



TUBE ADAPTORS FOR X-LOK COMPRESSION FITTINGS (1500PSI)

Scanivalve has designed easy-to-use tube adaptors that fit X-Lok fittings. The main function of these tube adaptors is to reduce 1/8 or 1/4 inch input fittings to our stainless steel tubulations or other.

These fittings can be hand tightened to form a leak tight O-ring seal. No tools are required. The tube adaptor material is brass or stainless steel with brass or stainless steel tubulations (dependent on configuration).

To Order, Specify: Scanivalve Part Number + Dash Number

Scanivalve Part #	Dash Number	Tubulation Size	X-Lok Compression Fitting Size
5365	- 1	Cap	1/4" [6mm]
	- 12	.040"	
	- 2	.063"	
	- 4	.083"	
	- 3	.125"	
5375	- 2	Cap	1/8" [3mm]
	- 4	.040"	
	- 1	.063"	
	- 5	.125"	

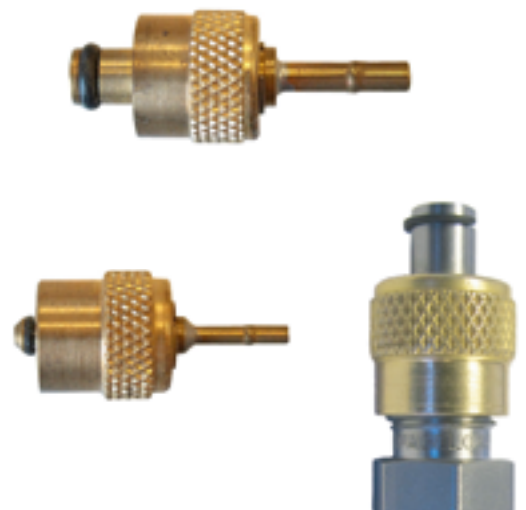

X-LOK TO TUBULATION

These fittings provide a compression fitting to one end and a tubulation on the other. This fitting can be threaded or mounted to a wall to provide a pass through option when converting compression fittings to tubulations. The material can be stainless steel or brass. The nut included for the 1/8 pipe thread is brass.

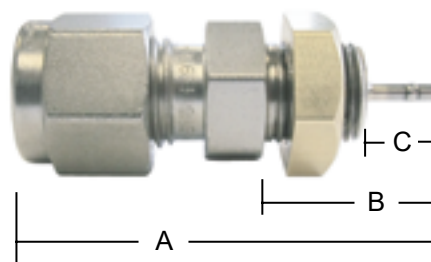

To Order, Specify: Scanivalve Part Number + Dash number

Scanivalve Part #	Dash Number	Tubulation Size Inches [mm]	Material	Compression Fitting	NPT Size	A	B	C
						Inches [mm]		
57022	- 1	.063 [1.59]	Brass	1/4" (6mm)	1/8"	1.660 [42.16]	.745 [18.92]	.370 [9.40]
	- 2	.125 [3.18]				1.880 [47.75]	.965 [24.51]	.590 [14.99]
	- 3	.063 [1.59]	Stainless Steel			1.660 [42.16]	.745 [18.92]	.370 [9.40]
	- 4	.125 [3.18]				1.880 [47.75]	.965 [24.51]	.590 [14.99]
57032	- 1	.063 [1.59]	Brass	1/8" (3mm)	1/8"	1.570 [39.88]	.745 [18.92]	.370 [9.40]
	- 2	.125 [3.18]				1.770 [44.96]	.945 [24.00]	.570 [14.48]
	- 3	.063 [1.59]	Stainless Steel			1.600 [40.64]	.775 [19.69]	.400 [10.16]
	- 4	.125 [3.18]				1.770 [44.96]	.945 [24.00]	.570 [14.48]

TUBE INSERTS FOR X-LOK COMPRESSION FITTINGS

Scanivalve has designed easy-to-use tube adaptors that fit into X-Lok compression fittings. The main function of these tube adaptors is to utilize the compression fitting and adapt to Scanivalve tubulation sizes. These adaptors are all stainless steel.



To Order, Specify: Scanivalve Part Number + Dash Number

Scanivalve Part #	Dash Number	Tubulation Size Inches [mm]	Material	Body O.D - 'D' Inches [mm]
57038	- 1	.063 [1.59]	Stainless Steel	.250 [6.35]
	- 2	.125 [3.18]		.250 [6.35]
	- 3	.063 [1.59]		.125 [3.18]
	- 7	.040 [1.02]		.125 [3.18]

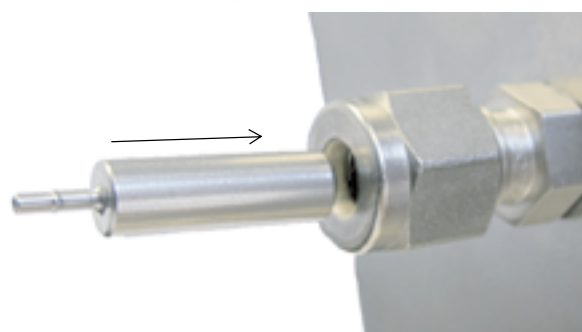



■ PRESSURE TAP

These pressure taps were designed to be a convenient solution for mounting tubulations to a model or test article. Using a hole drilled in the test article, the pressure tap can be fixed to the test article using adhesive. The through hole design of the tap (Dimension A) will allow for a flush finish on the exterior of the test article. Straight and 90 degree tubulation variants are available.



Tubulation Sizes Available: .040" and .063"

To Order, Specify: Scanivalve Part Number + Dash number

Scanivalve Part Number	Tubulation Size	Orientation
5855	.040	Straight
5856	.063	Straight
5865	.040	90 Degree
5866	.063	90 Degree

Dash Number						
	- 1	- 2	- 3	- 4	- 5	- 6
'A'	.025 [.635]	.032 [.813]	.050 [1.27]	.063 [1.60]	.093 [2.36]	.125 [3.18]

Please consider test article material thickness when choosing the 'A' dimension.

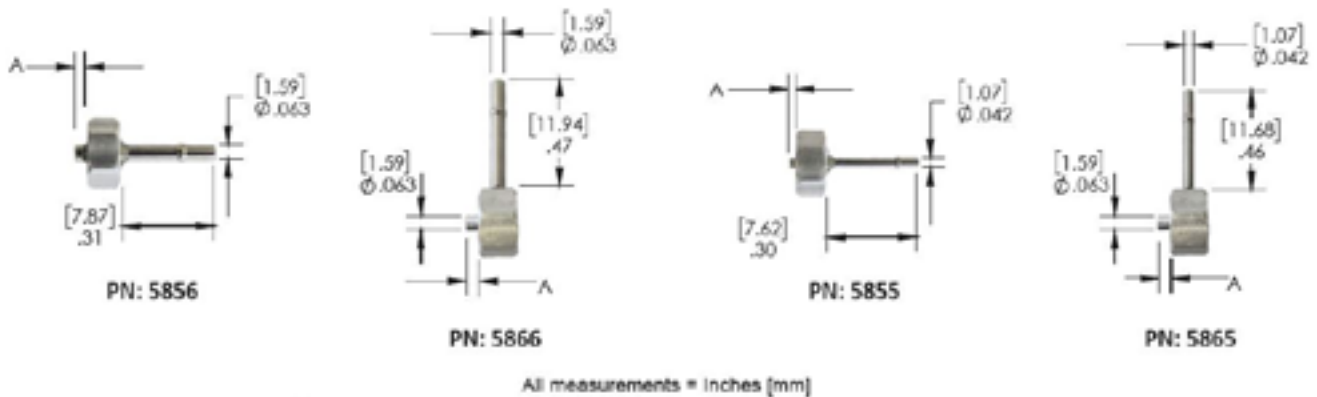

■ PRESSURE PATCH

The Pressure Patch is an alternate solution to the pressure tap in applications where drilling holes in the test article is unacceptable or inconvenient. A stainless steel tube is extruded from the chamber of an aluminum disk. The aluminum body can be fixed to the test article using an appropriate adhesive based on the application. The patch was designed and tested to have minimal aerodynamic influences when fixed to the flat surface of a test article.

Tubulation Sizes Available: .040" (non-bulged)
To Order, Specify: Pressure Patch (PN: 5857)

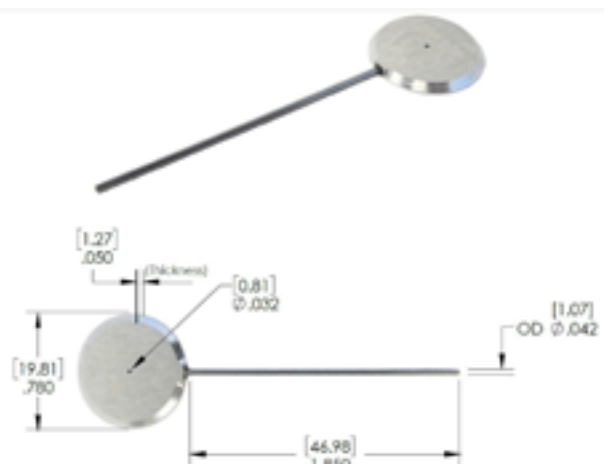

All measurements = Inches [mm]



QUICK DISCONNECT (50-100PSI)

This family of connectors are ideal for making quick disconnects at test break points where space is important. These connectors have some of the highest channel density per connector that Scanivalve offers. A flat gasket is shipped with the male connector for providing an air tight seal. Blanking caps are available for some connector models as shown in the chart below.

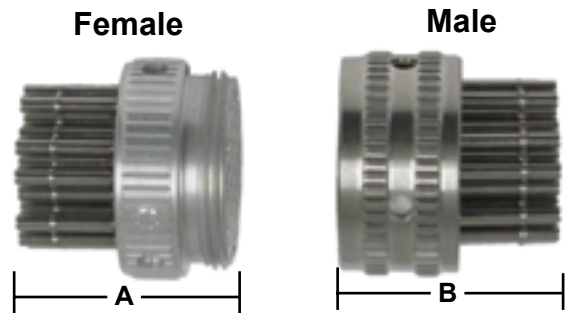

Dimensions: Inches [mm]				
Number of Tubulations	Connector Diameter	A	B	Tubulation Dimensions
7	.345 [8.76]	.680 [17.3]	.615 [15.6]	.040 [1.02] O.D.
14	.390 [9.91]	.695 [17.65]	.680 [17.3]	.040 [1.02] O.D.
19	.460 [11.7]	.660 [16.8]	.690 [17.6]	.031 [.79] O.D.†
19	.460 [11.7]	.760 [19.3]	.790 [20.1]	.040 [1.02] O.D.
31	.560 [14.2]	.540 [13.7]	.650 [16.5]	.031 [.79] O.D.†
31	.560 [14.2]	.540 [13.7]	.580 [14.7]	.040 [1.02] O.D.
31	.900 [22.9]	.720 [18.3]	.765 [19.4]	.040 [1.02] O.D.
31	.900 [22.9]	.690 [17.6]	.765 [19.4]	.063 [1.59] O.D.
36	.625 [15.88]	.615 [15.6]	.655 [16.6]	.031 [.79] O.D.†
36	.625 [15.88]	.960 [24.4]	1.0 [25.4]	.040 [1.02] O.D.
55	.700 [17.8]	.540 [13.7]	.565 [14.4]	.040 [1.02] O.D.
55	1.125 [28.6]	.690 [17.6]	.784 [19.9]	.063 [1.59] O.D.

A and B dimensions are the distance to the longest tube.

† All .031 tubulations are non-bulged

To order, specify: Connector # + Tube Size						
Number of Tubulations	Male Connector #	Female Connector #	Tube Size	Spare Gasket #	Male Cap #	Female Cap #
7	7M345‡	7F345‡	040	50968-1	N/A	N/A
14	14M390‡	14F390‡	040	50958-1	N/A	N/A
19	19M460	19F460	031	50059-2	50013-3	50024-3
19	19M460^^	19F460^^	040	50059-2	50013-3	50024-3
31	31M560	31F560*	031	50159-2	50013-2	50024-2
31	31M560^	31F560*^	040	50159-2	50013-2	50024-2
31	31M900	31F900*	040	50139-2	50130-9	50131-2
31	31M900	31F900*	063	50139-2	50130-9	50131-2
36	36M625	36F625*	031	50778-1	50770-3	50776-3
36	36M625^^	36F625*^^	040	50778-1	50770-3	50776-3
55	55M700	55F700	040	50007-3	50013-1	50024-1
55	55M1.125	55F1.125	063	50129-1	N/A	50110-1

^Available in pyramid configuration. Specify at time of order.

^^ Only available in pyramid configuration.

‡ Max Pressure 50psi

* Available in Female Bulkhead

Note: Male Cap for Female Connector
Female Cap for Male Connector
Prices may vary based on configuration



Standard Configuration



Pyramid Configuration



MODEL D (300PSI)

The "D" Connectors make ideal quick disconnects at model test break points when both male and female connectors are used together. Both connectors are available with 24 or 48 stainless steel tubulations. Standard "D" connectors use a gasket and are limited to 100psi. For applications up to 300 psi, a gasgace can be used and must be specified at the time of order. Male and female halves can be mated together to act as a reducer. Please consult the factory for this configuration.

Spare Gasket Part Number: 6088

Spare Gasgace Part Number: 6058

To Order, Specify:

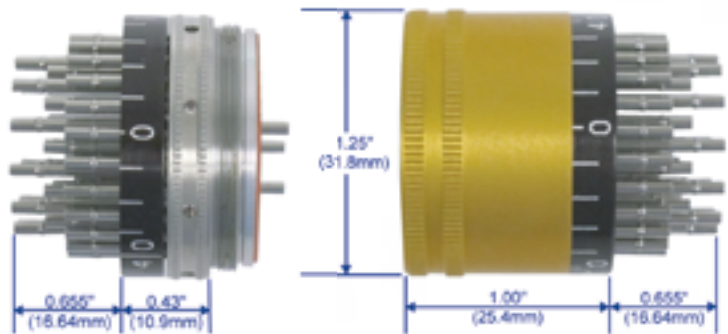
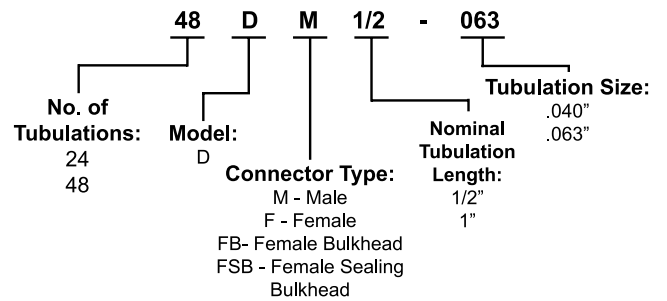

48DM-1/2
(Male)

48DF-1/2
(Female)

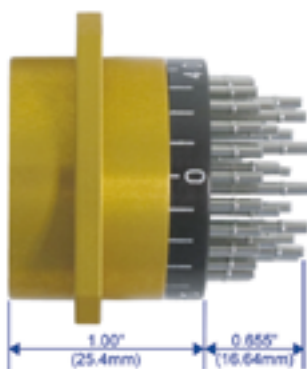

48DFB-1/2
(Female Bulkhead)

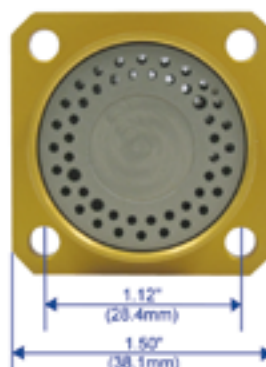

0.16" (4.06mm)
Diameter Holes
4 each



■ 24C, 48C, AND 64C

The line of CM (male) connectors, when used with a CF (female connector), or a CFB (female bulkhead connector), become ideal quick disconnects at pressure break points. The stainless steel tubulations are designed to fit either Scanivalve 040, 063, or 125 tubing. A 2 inch retainer is available as an additional option.

Blanking caps, spare O-rings, gaskets, and gascages can be found in the table on the following page.



64CFB-1



64CF-1

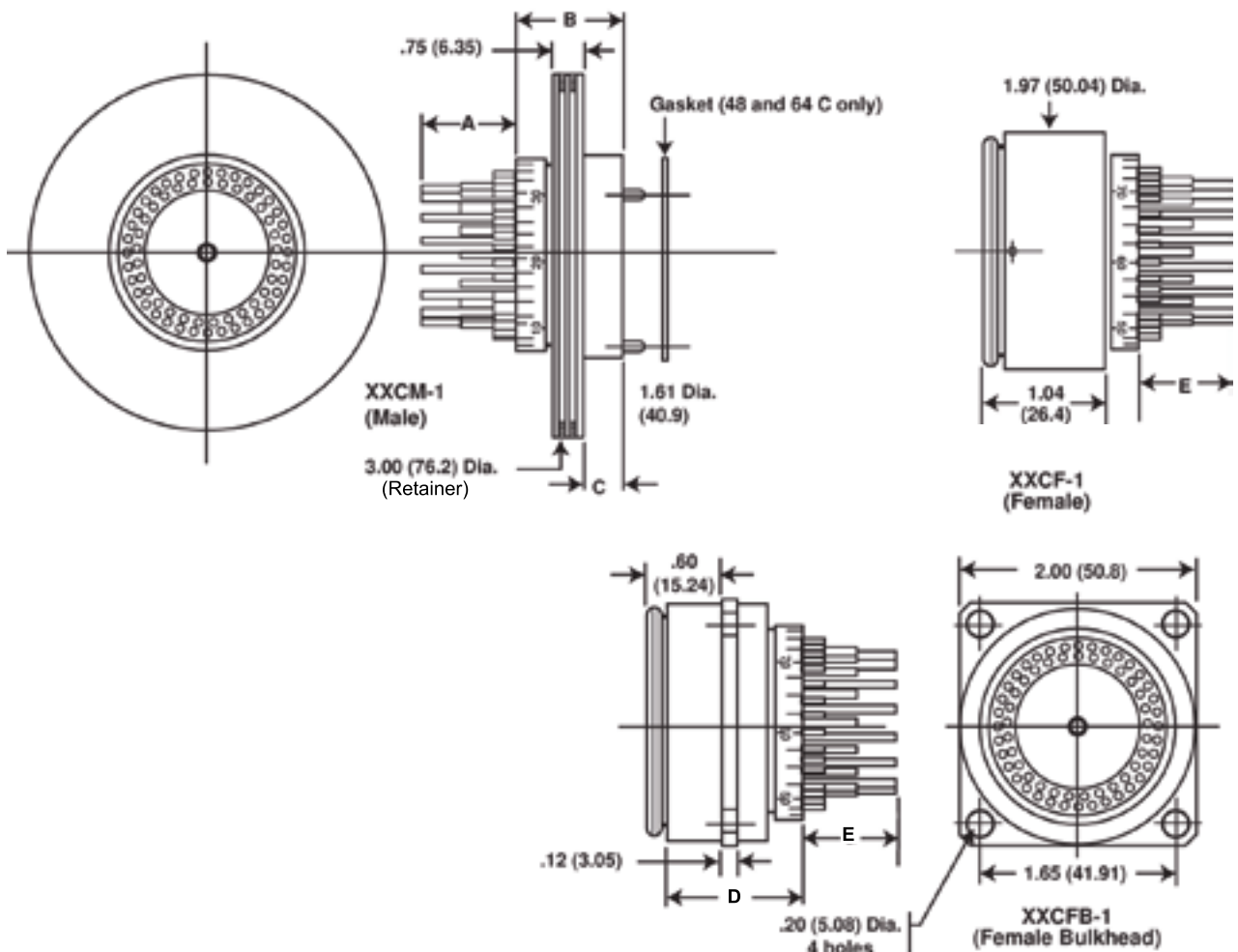



24C Connector Dimensions (500psi)

ScanCo#	Description	No. of Tubes	Tubulation Size	A	B	C	D	E	Cap
24CM-1	Male Connector	24	.063 [1.59]	.61 [15.5]	.90 [22.9]	.36 [9.14]			65020-14
			.125 [3.18]	.86 [21.8]					
24CF-1	Female Connector	24	.063 [1.59]					.41 [10.4]	65010-9
			.125 [3.18]					.86 [21.8]	
24CFB-1	Female Bulkhead Connector	24	.063 [1.59]				1.30 [33.0]	.41 [10.4]	65010-9
			.125 [3.18]					.86 [21.8]	
0995-070X-150B - Spare O-Rings									

48C Connector Dimensions (500psi)

ScanCo#	Description	No. of Tubes	Tubulation Size	A	B	C	D	E	Cap
48CM-1	Male Connector	48	.040 [1.02]	.38 [9.7]	.82 [20.8]	.34 [8.64]			NA
			.063" [1.59]	.82 [20.8]					
48CF-1	Female Connector	48	.040 [1.02]					.42 [10.7]	6386-1
			.063" [1.59]					.83 [21.1]	
48CFB-1	Female Bulkhead Connector	48	.040 [1.02]				1.13 [28.7]	.42 [10.7]	6386-1
			.063" [1.59]					.83 [21.1]	
6025	Spare Gasket								
5180	Optional Gascage								

64C Connector Dimensions (100psi)*

ScanCo#	Description	No. of Tubes	Tubulation Size	A	B	C	D	E	Cap
64CM-1	Male Connector	64	.063 [1.59]	.77 [19.6]	.87 [22.1]	.34 [8.64]			NA
64CF-1	Female Connector	64	.063 [1.59]					.78 [19.8]	NA
64CFB-1	Female Bulkhead Connector	64	.063 [1.59]					1.17 [29.2]	.78 [19.8]
6305	Spare Gasket								
6015	Optional Gascage								

*Can be used up to 500psi with gascage. Please consult factory.
All measurements = Inches [mm]



ZOC (500PSI)

This high density 48 or 73 channel connector is a very popular bulkhead quick disconnect. It contains either .063 inch O.D. tubulations or .040 inch O.D. tubulations. This pneumatic connector is also used on our ZOCTCU Thermal Control Units. It is capable for use up to 500 psi. Male and female halves can be mated together to act as a reducer. Please consult the factory for this configuration.



To Order, Specify:

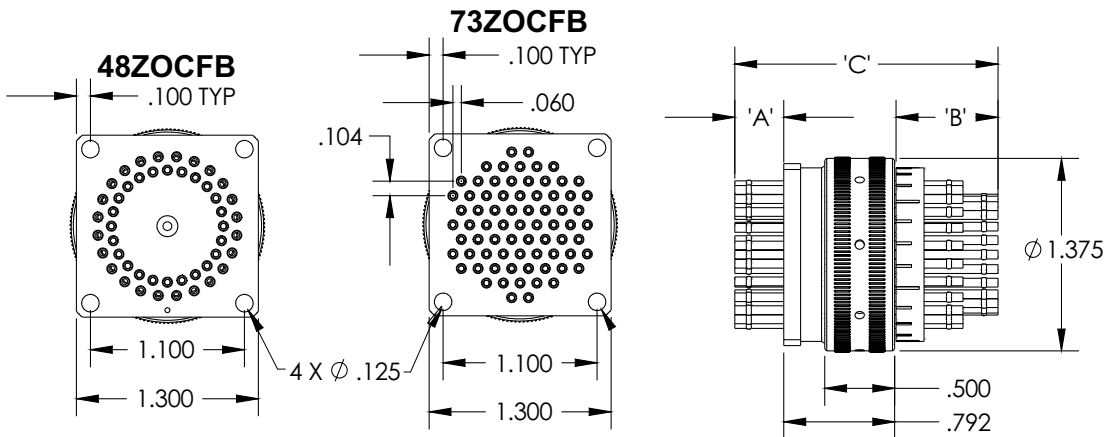
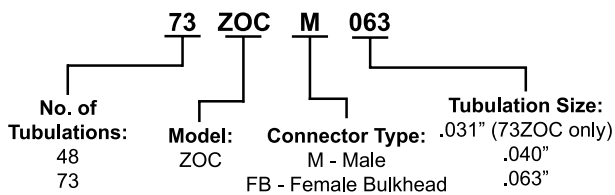

ScanCo#	Description	No. of Tubes	Tubulation Size	A	B	C (M & F/FB)	Spare Gascage	Mating Cap
48ZOC-M	Male Connector	48	.040 [1.02]		.990 [25.14]	2.04 [51.82]	5180-1	6541-4
			.063 [1.59]		1.3 [33.02]	2.44 [61.98]		
48ZOC-FB	Female Bulkhead Connector	48	.040 [1.02]	.260 [6.60]			5180-1	6530-3
			.063 [1.59]	.350 [8.89]				
73ZOC-M	Male Connector	73	.031 [.79]*		.300 [7.62]	1.350 [34.29]	6557-1	6561-9
			.040 [1.02]		1.050 [26.67]	2.070 [52.58]		
			.063 [1.59]		1.380 [35.05]	2.500 [63.5]		
73ZOC-FB	Female Bulkhead Connector	73	.031 [.79]"	.260 [6.60]			6557-1	6570-4
			.040 [1.02]	.230 [5.84]				
			.063 [1.59]	.330 [8.38]				

* .031 tubulations are non-bulged and non-staggered
All measurements = Inches [mm]



32MPS (100PSI)

The "32MPS" Connectors make ideal quick disconnects at model test break points when both male and female connectors are used together. These connectors were based around the MPS4264 input header and contain the same ports. The connector consists of 32 ports of 0.031 (non bulged) or 0.040 tubulations, and one purge port (always 0.063). The female connector has threaded holes and houses the O-Rings that seal the ports. Male and female halves with different tubulation sizes can be mated together to act as a reducer. Please consult the factory for this configuration.

Spare O-Rings for 32MPS Connector Part Number: 1443
Blanking cap for Male and Female connectors are available.

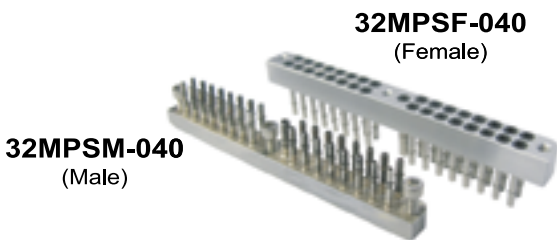

To Order, Specify:

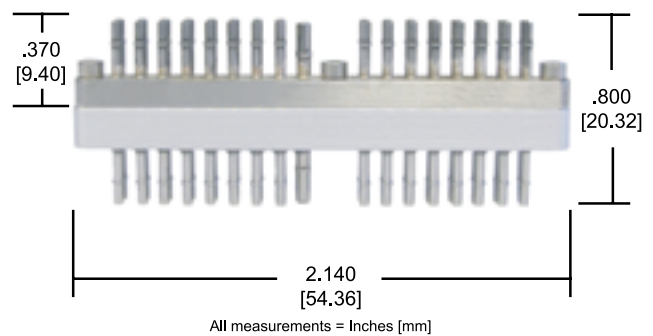
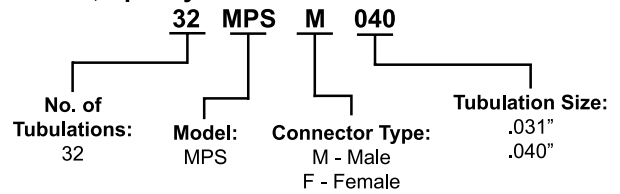

70MPSFI-040

70MPSM-040

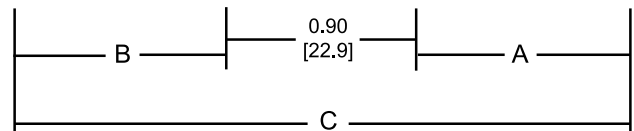

	A	B	C	Diameter
70MPS (0.063)	1.380 [35.1]	1.350 [34.3]	3.62 [91.9]	1.375 [34.9]
70MPS (0.040)	1.050 [26.7]	1.060 [26.9]	3.00 [76.2]	
70MPS (0.031*) (non-pyramid)	0.510 [13.0]	0.390 [9.9]	1.830 [46.5]	

All measurements = Inches [mm]
* All 031 tubulations are non-bulged

70MPS (500PSI)

The "70MPS" Connectors make ideal quick disconnects at model test break points when both male and female connectors are used together. These pneumatic connectors are used on the MPSTCU and are rated for operating temperatures from -60°C to 125°C. The connector consists of 70 tubulation ports - 64 ports for "Px" connections in 0.031 (non-bulged, non-pyramid), 0.040, or 0.063 tubulations. The remaining 6 tubulations are always 0.063 tubulations - which were designed for the control inputs on the MPS. A gascage will be supplied with each male connector. Male and female halves with different tubulation sizes can be mated together to act as a reducer. Please consult the factory for this configuration.

Spare Gascage Part Number: 6557
Blanking cap for Male and Female connectors are available.

To Order, Specify:

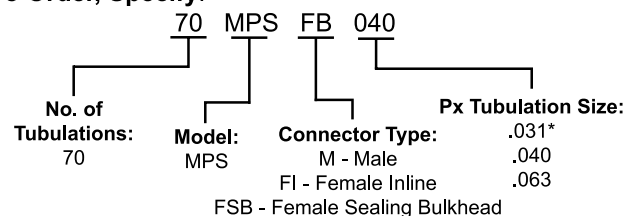



MODEL L (1500PSI)

The 48L series connectors are ideal for making quick disconnects at test break points. These connectors accept stainless steel tubing that is locked in place with a set screw. This tubing must be smooth ended .063" O.D. stainless steel tubing. Six mounting holes are drilled in the Female Bulkhead connector half which allow 8-32 screws to be used for mounting.

Note: Tubing supplied by customer must have smooth end, or order PN: TUBN-063-X (See page 4 for reference,

Blanking caps are available:

To cap off 48LM, order PN: 6245-1

To cap off 48LFB order PN: 6244-1

48LM
Male

48LFB
Female
Bulkhead

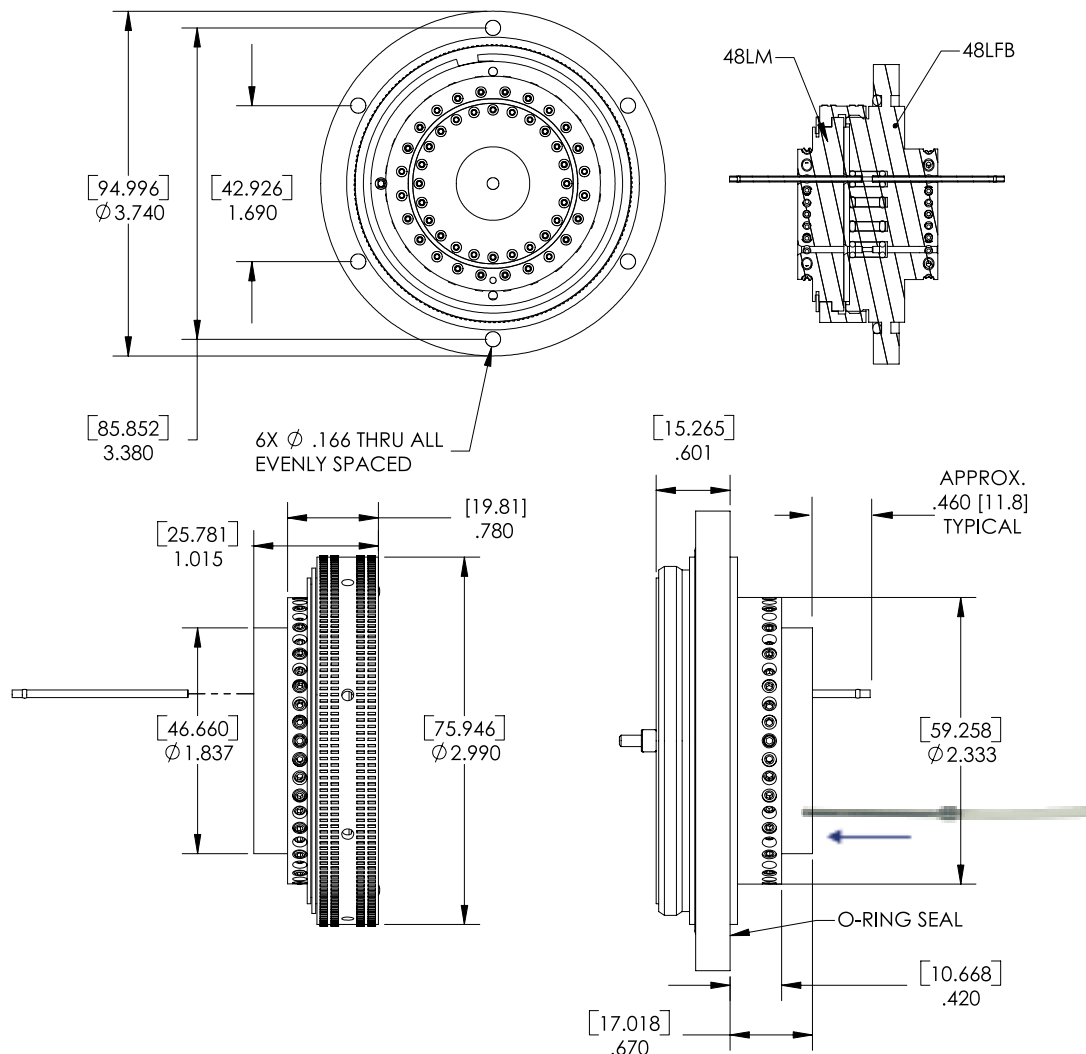

RC2 (300PSI)

The materials of construction for these connectors are stainless steel tubulations cemented into anodized aluminum blocks. These connectors utilize a gasstage to retain the o-rings and provide a leak-tight seal when connected. When configured with .031, .040, or .063 tubulations, different halves can be mated together to act as a reducer (this does not apply to the 125 tubulations). Please consult factory for this configuration.

Available Colors: CLR (clear), GLD (gold), BLK (black), RED, GRN (green) and BLU (blue). If color is not specified at the time of order, Scanivalve will supply a color based on availability.

Tubulation Sizes Available: .031 (non-bulged), .040, .063 and .125 inches O.D.

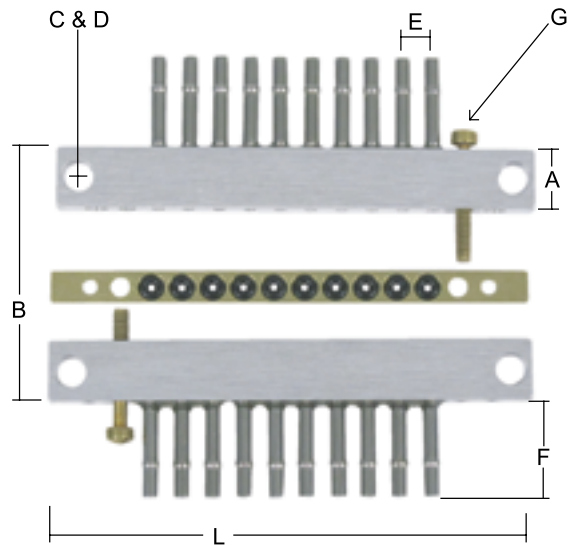

Number of Tubes	Connector Length "L" in Inches [mm]	
	For Tube Diameters:	
	.031, .040, .063	.125
8	1.700 [43.2]	2.875 [73.0]
10	1.950 [49.5]	3.375 [85.7]
12	2.200 [55.9]	3.875 [98.4]

Dimensions in Inches [mm]								
Tube Diameter	Thickness	A	B (Assembled)	C (Hole Diameter)	D	E	F	G (Scanco #)
.031	.125 [3.18]	.250 [6.35]	.532 [13.51]	.125 [3.18]	No. 4 Mounting Screw	.125 [3.18]	.325 [8.26]	20300-02
.040							.375 [9.53]	
.063							.385 [9.78]	
.125	.250 [6.35]	.375 [9.53]	.782 [19.86]	.140 [3.56]	No. 6 Mounting Screw	.250 [6.35]	.47 [11.94]	20300-06

Each half of the connector can have different tubulation size, but body size will remain unchanged.

To Order, specify: Two (2) each RC2 connectors plus a gasstage are required to make one connector assembly.

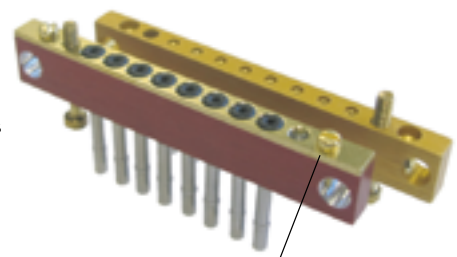
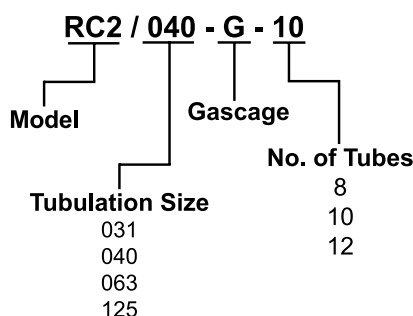
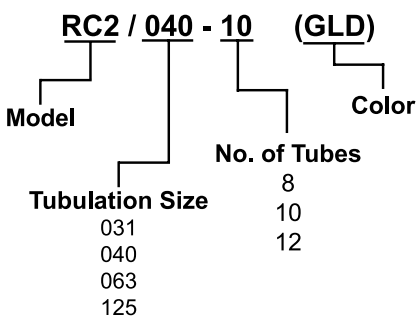

Screws supplied with gasstage to fasten gasstage to one half of the connector.



■ RPC (100-500PSI*)

The pneumatic manifolds are available in two designs, single manifold and double manifold. Tubulation sizes are .040 inch, .063 inch and .125 inch O.D. Lengths of the manifold are customer specified based on number of tubes. The maximum number is 12 tubes for a single manifold and 24 tubes for a double manifold.

Materials: Connector body is anodized aluminum. Tubulations are stainless steel.

Available Colors: CLR (clear), BLK (black), GLD (gold), RED, BLU (blue), and GRN (green). If a color is not specified at time of order, Scanivalve will supply a color based on availability.

M - Single Manifold
(12 tube Maximum)

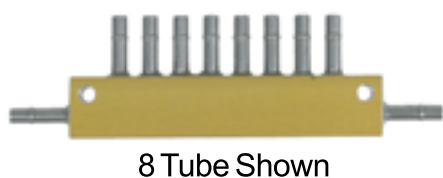

8 Tube Shown

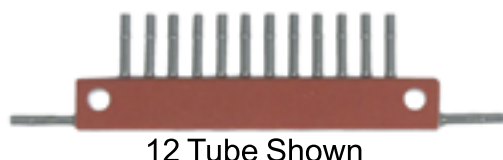

12 Tube Shown

2M - Double Manifold
(24 tube Maximum)

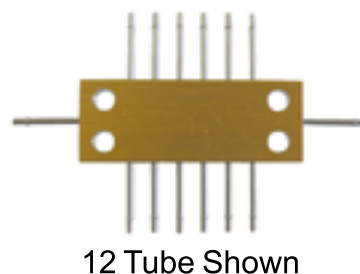

12 Tube Shown

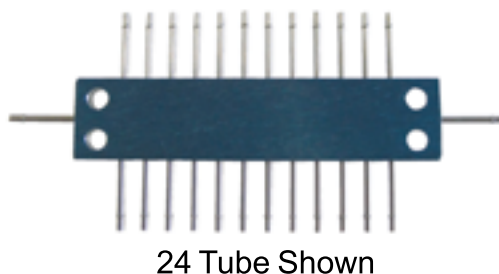

24 Tube Shown

To order, specify Scanivalve #:	
Single Manifolds	Double Manifolds
TC 040 - M 3 (Color)	TC 040 - 2M 4 (Color)
TC 063 - M 3 (Color)	TC 063 - 2M 4 (Color)
TC 125 - M 3 (Color)	TC 125 - 2M 4 (Color)

Tube Connector Specify Color
 Tubulation Size No. of Tubes
 Single Manifold



Tube Connector Specify Color
 Tubulation Size No. of Tubes
 Double Manifold



These connectors are made by affixing stainless steel tubulations into colored anodized aluminum blocks. The tube connectors are optionally available with a brass body with stainless steel tubulations soldered to the connector body for enhanced durability in harsh environments. All tubulations are bulged (except .031 and .250) for use with Scanivalve Helical Tubing Clamps.

Available Colors: CLR (clear), GLD (gold), BLK (black), RED, GRN (green), and BLU (blue). If a color is not specified at the time of order, Scanivalve will supply a color based upon availability.

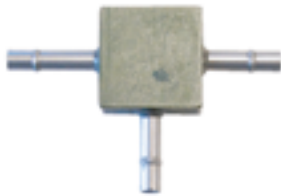
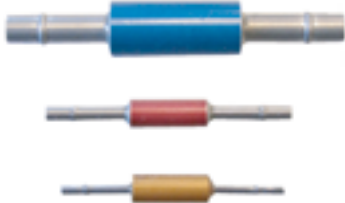
Sizes Available: .031 (no bulge), .040, .063, .125, .250 (no bulge) inches O.D. All tubulation size combinations are available.

To order, specify:			
Item:	Scanivalve #:	Type:	Design:
Tube Connector "X" Design	TC 040 X (specify color) TC 063 X TC 125 X	"X"	
Tube Connector "T" Design	TC 040 T (specify color) TC 063 T TC 125 T	"T"	
Tube Connector "I" Design* (for color identification of pressure lines)	TC 040 I (specify color) TC 063 I TC 125 I	"I"	
Tube Connector "R" Design*	TC 040-031 R (specify color) TC 063-031 R TC 063-040 R TC 125-031 R TC 125-040 R TC 125-063 R TC 187-125 R TC 250-063 R	"R"	
Tube Connector "P" Design	TC 040 P (specify color) TC 063 P TC 125 P	"P"	

Tube
Connector

Tubulation
Size

Design
Type

*Two sizes required for "R" Connector



QUICK COUPLER (PATENTED)

This quick coupler is designed for use during pressure testing where there is a need for changing pressure inputs quickly. They can be used with various lengths of stainless steel tubing with chamfered ends. The QC063-2 quick coupler is capable of operating at pressures up to 1000 psi.

Use:

1. To connect, push smooth end of tubing into coupler. Tubing is sealed with a captured internal O-ring and mechanically held by the collet which is initially closed by spring force. When the coupler is pressureized, an internal piston applies additional closing force to the collet.

2. To disconnect, shut off the air supply and then depress the collet.

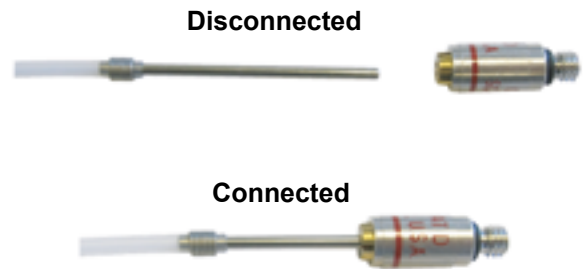

QUICK COUPLER DESIGNS

QC-XXX-2

The model -2 quick coupler design incorporates 2 collets in order to accept a steel tubulation at each end.



QC063-2

QC-XXX-TH

The model -TH quick coupler design incorporates a collet at one end and a threaded nose and O-Ring at the other end. The .063 version comes with an 8-32 thread, and the .125 version has a 1/4-28 thread.



QC063-TH8

QC-XXX-TUBN-XXX

The model -TUBN quick coupler design incorporates a collet at one end and a .063 or .125 inch tubulation on one end.



QC063-TUBN063

TUBN-XXX-X

See Stainless Steel Tubulations on page 3.

CAUTION:

Do not push bulged end of tubulation into coupler. A chamfered edge is required.

Ordering Information			
To order, specify Scanivalve #:		.063 O.D. Tubulation Size	.125 O.D. Tubulation Size
Collet Each End	Model-2	QC063-2	QC125-2
Thread One End	Model-TH	QC063-TH8	QC125-TH25
Tube One End	Model-TUBN	QC063-TUBN063	QC125-TUBN125



The pneumatic calibration/ purge valve is a 3 way, 8 channel (8P-3T) pneumatic logic valve ideal for calibrating up to 8 individual pressure transducers of similar pressure range. A 90-120 psi control pressure is required to switch the valve from the default measurement mode to the calibration, purge, or isolate mode.

In calibration mode, input pressures are isolated allowing the user to apply a calibration to the 8 ports that are now manifolded together.

The Purge mode allows a purge pressure to be input to purge condensation or contamination back through the input tubes and away from the measurement equipment.

Ordering Information: ZOCCAL/ADPT

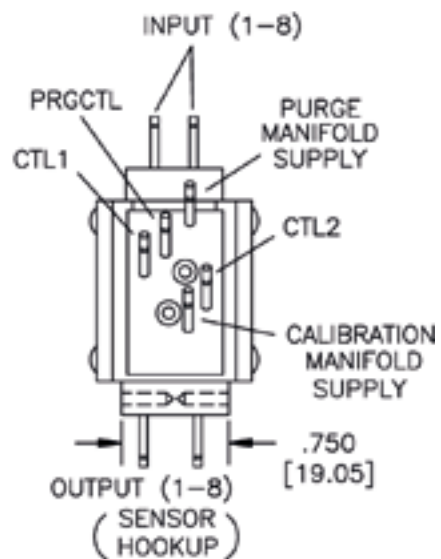
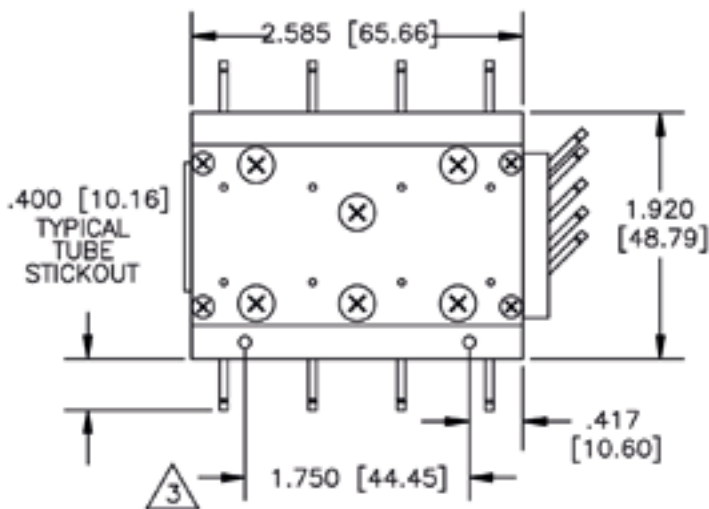
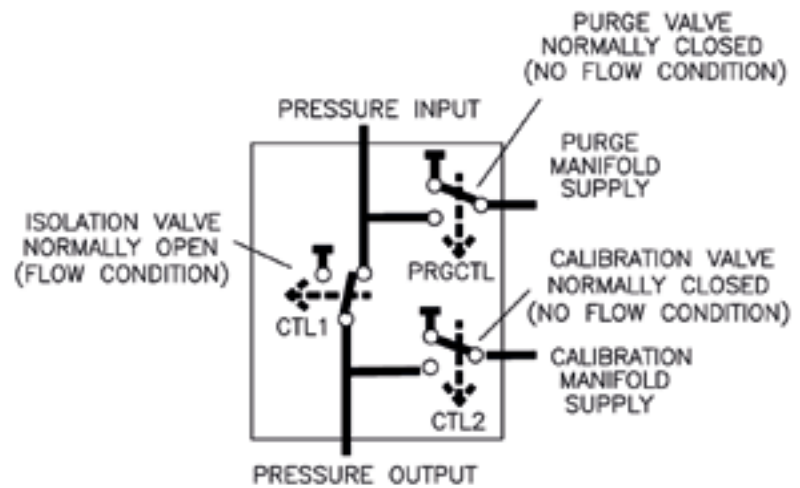

All measurements = Inches [mm]

Scanivalve Ethernet based Intelligent Pressure and Temperature Instruments.



Miniature Intelligent Pressure Measurement



Intelligent Gas Pressure Measurement



Intelligent Liquid Pressure Measurement



Intelligent Rack Mounted Pressure Measurement



Flight/Wind Tunnel/ Auto Pressure Test



Miniature Analog Pressure Scanners



Ethernet Scalable Remote A/D



Servo Pressure Calibrator



Intelligent Thermocouple Scanner 16, 32, and 64 Channels

















THE RIGHT SOLUTION FOR YOUR REQUIREMENTS

Due to our decades of experience, we at Althen can supply our customers with developments ranging from standard and customer-specific sensors to complete measuring systems.

All physical parameters are represented in our product range, using different technologies so that you always get the best solution for your measurement requirements. Thanks to our many years of experience, our technical know-how, our strong team of engineers with different professional backgrounds and our broad product range, we can offer the most efficient solutions for almost all applications in all branches of industry.

Our team will be happy to advise you. You can reach us by phone at **+49 6195 70060** or by e-mail to **sales@althen**.

OUR PRODUCT SCOPE

 bar	Pressure	 mm	Displacement	 g	Acceleration		Amplifier
 N	Force	 α	Rotation	 m/s^2	Vibration		Data Logger
 Nm	Torque		Joystick	 $\%/s$	Angular Rate		Automation
 ϵ	Strain		Inclination	 $^{\circ}C$	Temperature		Measurement Solutions



ALTHEN SENSORS & CONTROLS

■ Germany | Switzerland | Austria

ALTHEN GmbH Mess- und Sensortechnik
 Dieselstraße 2
 65779 Kelkheim
 Germany
 Phone: +49 6195 7 00 60
 Email: info@althen.de

■ Netherlands | Belgium | Luxembourg

ALTHEN bv Sensors & Controls
 Vlietweg 17a
 2266 KA Leidschendam
 Nederlands
 Phone: +31 70 3 92 44 21
 Email: sales@althen.nl

■ France

ALTHEN / DB Innovation
 26, avenue de la Méditerranée
 34110 Frontignan
 France
 Phone: +33 4 67 78 61 66
 Email: info@althensensors.fr

■ USA

ALTHEN Sensors & Controls Inc
 2531 Bradley Street
 Oceanside CA 92054
 USA
 Phone: +1 858 6 33 35 72
 Email: info@althensensors.com

■ Sweden

ALTHEN Sensors & Controls AB
 Gjuterivägen 10
 76140 Norrtälje
 Sweden
 Phone: +46 8 7 95 24 90
 Email: info@althensensors.se

Version: 07.2019



Further information can be found at althen.de