



**mm** P101  
Stand-Alone Linear Position Sensor

**FEATURES**

- Non-contacting inductive technology to eliminate wear
- Travel set to customer's requirement
- Compact and self-contained
- High durability and reliability
- High accuracy and stability
- Sealing to IP65/IP67 as required



Position feedback for industrial and scientific applications

Our P101 LIPS® (Linear Inductive Position Sensor) is an affordable, durable, high-accuracy position sensor designed for industrial and scientific feedback applications. The unit is highly compact and space-efficient, being responsive along almost its entire length.

The P101, sensors, provides a linear output proportional to travel. Each unit is supplied with the output calibrated to the travel required by the customer, any stroke from 0- 5mm to 0-800mm and with full EMC protection built in. The sensor is very robust, the body and push rod being made of stainless steel for long service life and environmental resistance. It is particularly suitable for OEMs seeking good sensor performance for arduous applications such as industrial machinery where cost is important.

Overall performance, repeatability and stability are outstanding over a wide temperature range. The sensor is easy to install with mounting options including M5 rod eye bearings and body clamps. The push rod can be supplied free or captive, with female M5 thread, an M5 rod eye, or dome end, Captive push rods can be sprung loaded, in either direction, on sensors up to 250mm of travel. The P101 also offers a wide range of mechanical and electrical options, environmental sealing is to IP65 or IP67, depending on selected cable or connector options.

**SPECIFICATION**

**Dimensions**

Body diameter	35 mm
Body length (Axial version)	calibrated travel + 163 mm
Body length (Radial version)	calibrated travel + 186 mm
Push rod extension	calibrated travel + 9 mm, OD 9.5 mm

For full mechanical details see drawing P101-11

<b>Independent Linearity</b>	≤ ± 0.25% FSO @ 20°C - up to 450 mm
	≤ ± 0.5% FSO @ 20°C - over 450 mm
	≤ ± 0.1% FSO @ 20°C* available upon request.

\*Sensors with calibrated travel from 10 mm up to 400 mm.

<b>Temperature Coefficients</b>	< ± 0.01%/°C Gain &
	< ± 0.01%FS/°C Offset

<b>Frequency response</b>	> 10 kHz (-3dB)
	> 300 Hz (-3dB) 2 wire 4 to 20 mA

<b>Resolution</b>	Infinite
-------------------	----------

<b>Noise</b>	< 0.02% FSO
--------------	-------------

**Environmental Temperature Limits**

Operating	-40°C to +125°C standard
	-20°C to +85°C buffered
Storage	-40°C to +125°C

<b>Sealing</b>	IP65/IP67 depending on connector / cable option
----------------	---

<b>EMC Performance</b>	EN 61000-6-2, EN 61000-6-3
------------------------	----------------------------

<b>Vibration</b>	IEC 68-2-6: 10 g
------------------	------------------

<b>Shock</b>	IEC 68-2-29: 40 g
--------------	-------------------

<b>MTBF</b>	350,000 hrs 40°C Gf
-------------	---------------------

**Drawing List**

P101-11	Sensor Outline
---------	----------------

Drawings, in AutoCAD® dwg or dxf format, available on request.

Do you need a position sensor made to order to suit a particular installation requirement or specification? We'll be happy to modify any of our designs to suit your needs - please contact us with your requirements.



## How PIPS® technology eliminates wear for longer life

The PIPS® technology is a major advance in displacement sensor design. PIPS®-based displacement transducers have the simplicity of a potentiometer with the life of an LVDT/RVDT.

PIPS® technology combines the best in fundamental inductive principles with advanced micro-electronic integrated circuit technology. A PIPS® sensor, based on simple inductive coils using ASIC control technology, directly measures absolute position giving a DC analogue output signal. Because there is no contact between moving electrical components, reliability is high and wear is eliminated for an exceptionally long life. PIPS® overcomes the drawbacks of LVDT technology – bulky coils, poor length-to-stroke ratio and the need for special magnetic materials. It requires no separate signal conditioning.

Our LIPS® range are linear sensors, while RIPS® are rotary units and TIPS® are for detecting tilt position. Ask us for a full technical explanation of PIPS® technology.

We also offer a range of ATEX-qualified intrinsically safe sensors.

## TABLE OF OPTIONS

**CALIBRATED TRAVEL:** Factory set to any length from 0-5mm to 0-800mm (e.g. 254mm)

### ELECTRICAL INTERFACE OPTIONS

OUTPUT SIGNAL	SUPPLY INPUT	OUTPUT LOAD
Standard: 0.5-4.5V dc ratiometric	+5 V dc nom. ± 0.5V.	5kΩ min.
Buffered: 0.5-4.5V dc ±5V dc	+24V dc nom. + 9-28V. ±15V dc nom. ± 9-28V.	5kΩ min. 5kΩ min.
0.5-9.5V dc ±10V dc	+24V dc nom. + 13-28V. ±15 V dc nom. ± 13.5-28V.	5kΩ min. 5kΩ min.
Supply Current	10 mA typical, 20mA maximum.	
4-20mA (2 wire)	+24 V dc nom. + 18-28V.	300Ω @ 24V.
(3 wire sink)	+24 V dc nom. + 13-28V.	950Ω @ 24V.
(3 wire source)	+24 V dc nom. + 13-28V.	300Ω max.

Axial sensors supplied with access to output 'zero' and 'span' calibration adjustments as standard. No access option available.

### CONNECTOR/CABLE OPTIONS

Connector - Hirschmann GD series	Axial, IP65
Connector - Hirschmann ELWIK 4102	Radial, IP67
Cable with M12 gland or short gland	Axial, IP67
Cable with Pg 9 gland	Radial, IP67
Cable length >5.0 cm – please specify length in cm	

### MOUNTING OPTIONS

M5 rod eye bearing (radial versions), Body Tube Clamp/s (axial or radial versions).

**PUSH ROD OPTIONS** – standard retained with M5x0.8 female thread, M5 rod eye bearing, Dome end, Sprung loaded (retraction or extension) or Free.

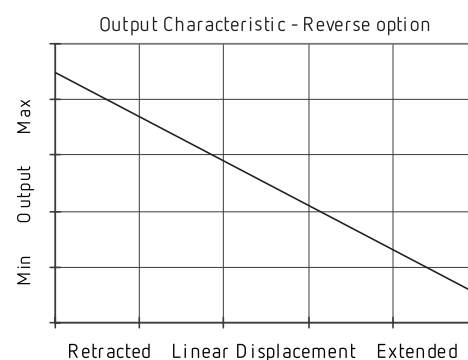
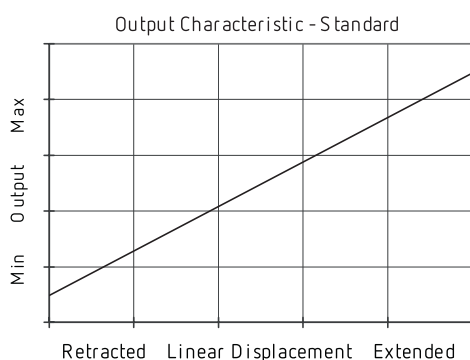



**HOW TO ORDER**

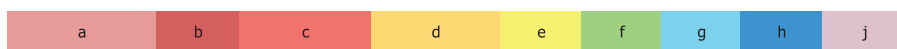

P101 . Displacement Output Adjustments Connections Option Option Option Option Z-code

a Displacement (mm)		Value
Displacement in mm	e.g. 0 - 254 mm	<b>254</b>
b Output		Code
Supply V dc V <sub>s</sub> (tolerance)	Output	Code
+5V (4.5 - 5.5V)	0.5 - 4.5V (ratiometric with supply)	<b>A</b>
±15V nom. (±9 - 28V)	±5V	<b>B</b>
+24V nom. (13 - 28V)	0.5 - 9.5V	<b>C</b>
±15V nom. (±13.5 - 28V)	±10V	<b>D</b>
+24V nom. (18 - 28V)	4 - 20mA 2 wire	<b>E</b>
+24V nom. (13 - 28V)	4 - 20mA 3 wire Sink	<b>F</b>
+24V nom. (9 - 28V)	0.5 - 4.5V	<b>G</b>
+24V nom. (13 - 28V)	4 - 20mA 3 wire Source	<b>H</b>
c Calibration Adjustments		Code
Accessible - default <sup>†</sup>	<sup>†</sup> Axial body style only. Radial body style sealed by default.	blank
Sealed		<b>Y</b>
d Connections Cable* or Connector		Code
Cable Gland - Radial	IP67 Pg9	<b>Ixx</b>
Connector - Axial	IP65 DIN 43650 'C'	<b>J</b>
Connector - Radial	IP67 M12 IEC 60947-5-2	<b>K</b>
Cable Gland - Axial	IP67 M12	<b>Lxx</b>
Cable Gland - Axial	IP67 Short	<b>Mxx</b>
<small>*Supplied with 50 cm as standard, specify required cable length specified in cm. e.g. L2000 specifies cable gland with 20 metres of cable. Nb: restricted cable pull strength.</small>		
e Body Fittings		Code
None - default		blank
M5 Rod-eye Bearing	Radial body style only	<b>N</b>
Body Clamps - 1 pair		<b>P</b>
Body Clamps - 2 pairs		<b>P2</b>
f Sprung Push Rod		Code
None - default		blank
Spring Extend	Up to 300mm displacement.	<b>R</b>
Spring Retract	Captive push rod only.	<b>S</b>
g Push Rod Fittings		Code
None - default		blank
Dome end	Required for option 'R'	<b>T</b>
M5 Rod-eye Bearing		<b>U</b>
h Push Rod Options		Code
Captive - default		blank
Non-captive	Push rod can depart body	<b>V</b>

j Z-code	Code
Connector IP67 M12 IEC 60947-5-2 must have options 'Y' & 'J'	<b>Z600</b>
Connector IP67 M12 IEC 60947-5-2 must have option 'J'	<b>Z601</b>
±± 0.1% @20°C Independent Linearity displacement between 10mm & 400mm only!	<b>Z650</b>
Connector with cable option 'J' or 'K' with length required in cm i.e. J100 specifies connector with 100cm of cable.	<b>Z999</b>



**INSTALLATION INFORMATION**

Output Option	Output Description:	Supply Voltage: $V_s$ (tolerance)	Load resistance: (include leads for 4 to 20mA O/Ps)
A	0.5 - 4.5V (ratiometric with supply)	+5V (4.5 - 5.5V)	$\geq 5k\Omega$
B	$\pm 5V$	$\pm 15V$ nom. ( $\pm 9 - 28V$ )	$\geq 5k\Omega$
C	0.5 - 9.5V	+24V nom. (13 - 28V)	$\geq 5k\Omega$
D	$\pm 10V$	$\pm 15V$ nom. ( $\pm 13.5 - 28V$ )	$\geq 5k\Omega$
E	4 - 20mA 2 wire Current Loop	+24V nom. (18 - 28V)	$\approx 0 - 300\Omega$ max. @ 24V ~ 1.2 to 6V across 300 $\Omega$ $\{R_L \text{ max.} = (V_s - 18) / 20^{-3}\}$
F	4 - 20mA 3 wire Sink	+24V nom. (13 - 28V)	$\approx 0 - 950\Omega$ max. @ 24V ~ 3.8 to 19V across 950 $\Omega$ $\{R_L \text{ max.} = (V_s - 5) / 20^{-3}\}$
G	0.5 - 4.5V	+24V nom. (9 - 28V)	$\geq 5k\Omega$
H	4 - 20mA 3 wire Source	+24V nom. (13 - 28V)	$\approx 0 - 300\Omega$ max. ~ 1.2 to 6V across 300 $\Omega$

Not all output options available - see product datasheet for full options list

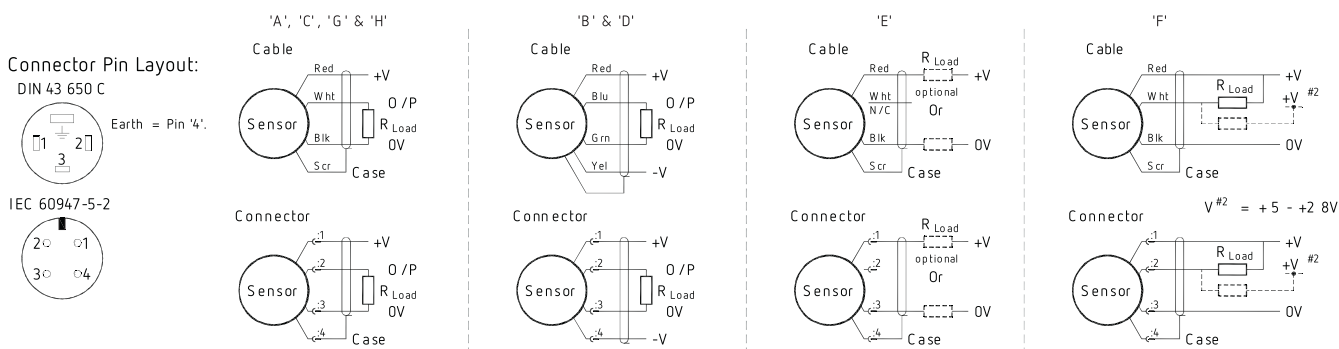

**Gain and Offset Adjustment:** (Where accessible - Typically  $\pm 10\%$  Min available)

To adjust the gain or offset use a small potentiometer adjuster or screwdriver 2mm across. Do not apply too much force on the potentiometers.

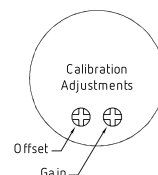

**Mechanical Mounting:** Depending on options; Body can be mounted by M5x0.8 male thread, M5 rod eye or by clamping the sensor body - body clamps are available, if not already ordered. Target by M5x0.8 female thread or M5 rod eye. It is assumed that the sensor and target mounting points share a common earth.

**Output Characteristic:** Target is extended 9 mm from end of body at start of normal travel. The output increases as the target extends from the sensor body, the calibrated stroke is between 5 mm and 800 mm.

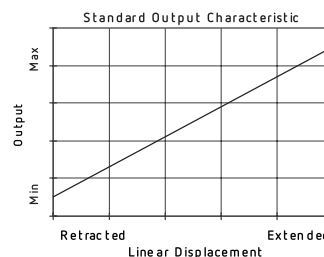

**Warning -** The M12 IEC 60947 connector may be rotated for purposes of convenient orientation of the connector and cable, however rotating the connector more than one complete revolution is not recommended.

**Repeated rotation of the connector will damage the internal wiring!**

**Incorrect Connection Protection levels:-**

- A **Not protected** – the sensor is **not** protected against either reverse polarity or over-voltage. The risk of damage should be minimal where the supply current is limited to less than 50mA.
- B & D Supply leads diode protected. Output must not be taken outside  $\pm 12V$ .
- C & G Supply leads diode protected. Output must not be taken outside 0 to 12 V.
- E, F & H Protected against any misconnection within the rated voltage.



**ELECTRICAL OPTIONS / SPECIFICATIONS**

N.b. ROD-EYE ORIENTATION NOT GUARANTEED.

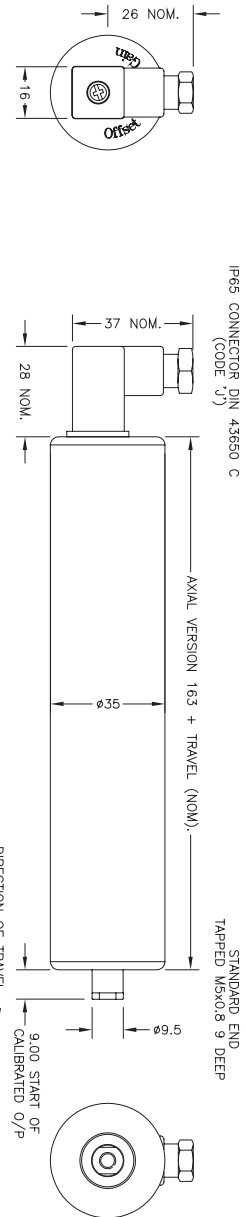

IP65 CONNECTOR DIN 43650 C  
(CODE U)

STANDARD END  
TAPPED M5x0.8 9 DEEP

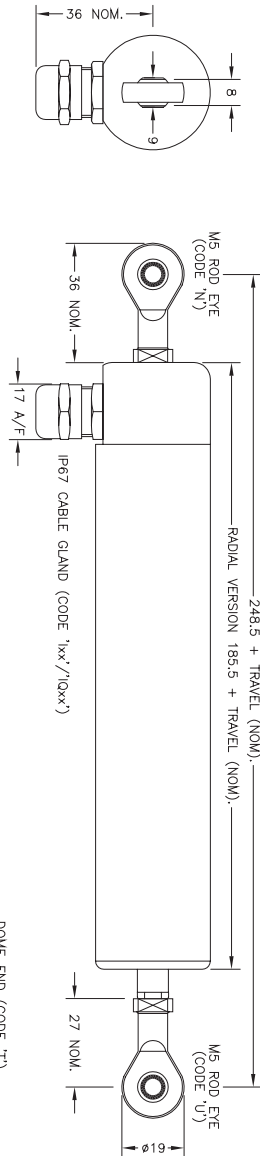

IP67 CABLE GLAND (CODE '1xx'/'10xx')

DOME END (CODE 'T')  
N.b. WITH OPTIONS 'R' OR 'S'.

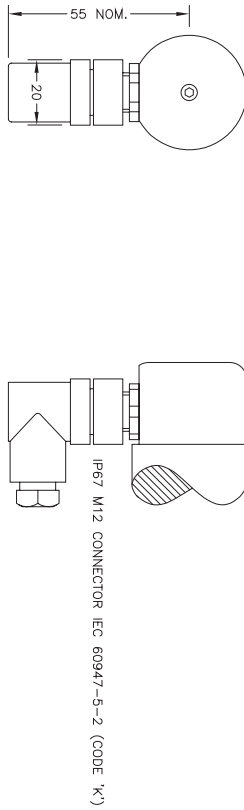

IP67 M12 CONNECTOR IEC 60947-5-2 (CODE 'K')

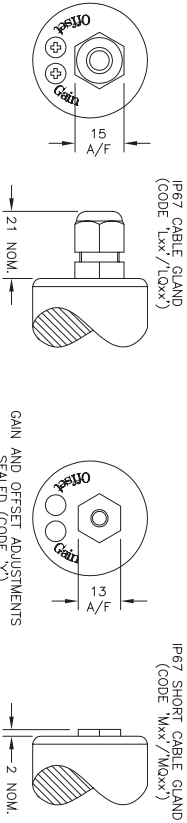

IP67 CABLE GLAND  
(CODE 'Lxx'/'L0xx')

IP67 SHORT CABLE GLAND  
(CODE '1xx'/'10xx')

GAIN AND OFFSET ADJUSTMENTS  
SEALED (CODE 'V')

P	ADDITIONAL DIMS/REV'S ADDED.	PDM
Q	RADIAL END-AN MODIF-D - RAN 335	PDM
R	SPRNG OPTIONS 3 00 WAS 250 - RAN 473.	PDM
S	OPTIONS 'R' & 'S' OVE R TRAVEL DIMS MODIFIED	PDM
T	RANGE WAS 50-400mm RAN1056	RDS
U	RANGE NOTE AMENDED - RAN1200	PDM



THE PUSH-ROD RETRACTS A FURTHER 4mm NOM. FROM START OF CALIBRATED TRAVEL. STANDARD VERSIONS THE PUSH-ROD EXTENDS A FURTHER 8mm NOM. FROM END OF CALIBRATED TRAVEL. FOR SPRUNG VERSIONS: 'R': 1mm., 'S': 2mm.

DRAWINGS NOT TO BE CHANGED WITHOUT REFERENCE TO THE CHANGE PROCEDURE.  
THIS IS AN UNCONTROLLED PRINT AND WILL NOT BE UPDATED.

OUTPUT OPTION	OUTPUT	SUPPLY
A	0.5 TO 4.5V RATIO-METRIC	5V
B	4-5V	±1.5V
C	0.5 TO 9.5V	24V
D	±10V	±1.5V
E	0.5 TO 4.5V	24V
F	SUPPLY CURRENT 12mA TYP. 20mA MAX.	24V
G	4 TO 20mA 2-WIRE SINK	24V
H	4 TO 20mA 3-WIRE SINK	24V
	4 TO 20mA 3-WIRE SOURCE	24V
	SINK VERSION OUTPUT COMPLIANCE 5-28V	
	SOURCE VERSION DRIVE 3000 MAX TO 0V	

CABLE: 0.2mm<sup>2</sup> O/A SCREEN, PUR JACKET - SUPPLIED WITH 50cm OR REQUIRED LENGTH IN cm. e.g. '150'

3-CORE: JACKET Ø4.0mm  
4-CORE: JACKET Ø4.8mm  
5-CORE: JACKET Ø5.5mm  
6-CORE: JACKET Ø6.3mm

CONNECTORS:  
RED :3 OV +ve  
GREEN :3 OV +ve  
YELLOW :4 -ve - OPTIONS: B OR D  
WHITE :2 OUTPUT - OPTIONS: A, C, E-H  
SCREEN :4 BODY - OPTIONS: A, C, E-H

\*CONNECTORS: MAXIMUM CONDUCTOR CROSS SECTION 0.75mm<sup>2</sup>  
RANGE OF DISPLACEMENT FROM 0-5mm TO 0-800mm e.g.76,  
IN INCREMENTS OF 1mm.

BODY MATERIAL: STAINLESS STEEL.

FURTHER OPTIONS:  
SINGLE END OF BODY CLAMP 'P'  
TWO ENDS OF BODY CLAMP 'P2'  
SPRING RETURN PUSH-ROD TRAVEL <300mm  
RETURN TO EXTENDED POSITION (CODE 'R')  
RETURN TO RETRACTED POSITION (CODE 'S')  
PUSH-ROD FREE (CODE 'V') - NOT AVAILABLE WITH SPRUNG OPTIONS.

GAIN AND OFFSET ADJUSTMENTS NOT AVAILABLE WITH RADIAL BODY, CODE '1xx' AND 'K', OPTIONS.

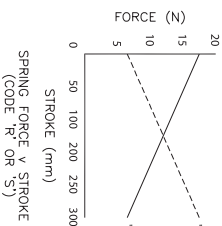

SPRING FORCE v/ STROKE  
(CODE 'R' OR 'S')

P	05/07/11	Checked by X	±0.4
Q	07/03/13	XX	±0.2
R	08/04/14	RDS	±0.1
S	28/07/15		±0.05
T	19/11/15	DESCRIPTION	
U	29/09/17	P101 LINS STAND ALONE LINEAR POSITION SENSOR	
SCALE 1:2.5mm		DRAWING NUMBER P 101-11	REV U
SHEET 1 OF 1			